

Gas Front Load Dryers

EIMGD55I RR/MB/IW

IQ-Touch™ Electronic Controls Featuring Perfect Steam™



Mediterranean Blue
EIMGD55I MB

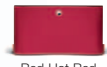

Red Hot Red



Mediterranean Blue



Island White

Optional Luxury-Glide®
Touch-2-Open™
Pedestals Shown in
Available Colors.

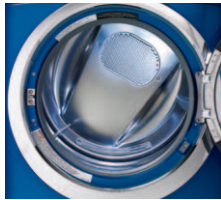

Largest Capacity Dryer¹

Dry the most in one load with 8.0 cu. ft. capacity.



Fast Dry Cycle²

Eighteen minutes to dry.

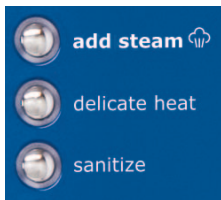

Perfect Steam™ Dryer

The latest technology removes wrinkles and freshens clothes. "Add Steam" option can be used with select cycles.



IQ-Touch™ Controls

The IQ-Touch™ control panel offers all the cycles/options you need – including a "My Favorite" setting.

27" GAS FRONT LOAD DRYERS

Capacity D.O.E.	8.0 Cu. Ft.
-----------------	-------------

Features

Signature Soft-Arc Door Design	Yes
IQ-Touch™ Electronic Controls with LCD Display	Yes
Perfect Steam™ Dry System	Yes
Gentle Tumble™ Dry System	Yes
Luxury-Quiet™ Sound System	Yes
Luxury-Design® Lighting	Yes
Luxury-Dry™ System	Yes
Touch-2-Open™/(Close) Door	Yes
Exact Dry™ Moisture Sensor	Yes
Stainless Steel Dryer Drum	Yes
Tumble Speed (RPM)	50
Reversible Door	Yes
Adjustable Leveling Legs	Yes
NSF® Certified	Sanitize

Cycles

Fast Dry, My Favorite (1), Heavy Duty, Bulky/Bedding, Mixed Load, Towels, Normal, Casual, Delicate, Touch Up, Timed Dry (*Can be used with Add Steam option)	11
--	----

Options

Temperature Selections	5
Add Steam	5
Electronic Auto Dry System	Yes
Manual Timed Dry Selections	5
End-of-Cycle Chime	Adjustable

Installation Options

Freestanding, Under Counter*, Stacked (Above Washer), Pedestal, Hidden (In Closet), Second Floor, 4-Way Dryer Venting	Yes
---	-----

Accessories

Luxury-Glide® Touch-2-Open™/(Close) Pedestal – Red Hot Red – PN# EPWD15RR, Mediterranean Blue – PN# EPWD15MB, Island White – PN# EPWD15IW	Optional
Dryer Stacking Kit – PN# STACKIT4X	Optional
LP Gas Conversion Kit – PN# PCK4200	Optional
Mobile Home Installation Kit – PN# 137067200	Optional
Drying Rack – PN# 134912700	Included

Specifications

Color –	
Red Hot Red	RR
Mediterranean Blue	MB
Island White	IW
Product Dimensions –	
Height (Without 15" Pedestal)	38"
(With 15" Pedestal)	53"
Width	27"
Depth (to Center of Arc Including Door and Exhaust) (with 90° Door Open)	31-1/2" 50-5/8"
Maximum Exhaust Duct Length³ (Ft.)	125
Gas/Power Supply Connection Location	Bottom Center Rear/ Bottom Right Rear
Voltage Rating	120V/60Hz/15A
Connected Load (kW Rating) @ 120 Volts‡	1.1
Amps @ 120 Volts	9
Heating Element (BTU/HR)	20,000
Shipping Weight (Approx.)	140 Lbs.

*Side-by-Side units in under-counter installation require custom-built countertop and/or cabinetry.

‡Fast time based on smallest load / Fast Wash and Fast Dry cycles selected for various load compositions.

³Rigid metal duct preferred, semi-rigid optional and allow deductions for elbows and vents. Refer to Installation Guide on web for additional information.

NOTE: Always consult local and national electric & gas codes. Refer to Product Installation Guide for detailed installation instructions on the web at www.electroluxappliances.com.

Specifications subject to change.

¹Based on manufacturer specifications.

²Fast time based on smallest load / Fast Wash and Fast Dry cycles selected for various load compositions.

³Rigid metal duct preferred, semi-rigid optional and allow deductions for elbows and vents. Refer to Installation Guide on web for additional information.



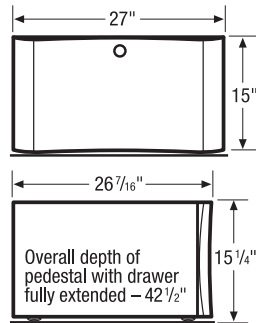
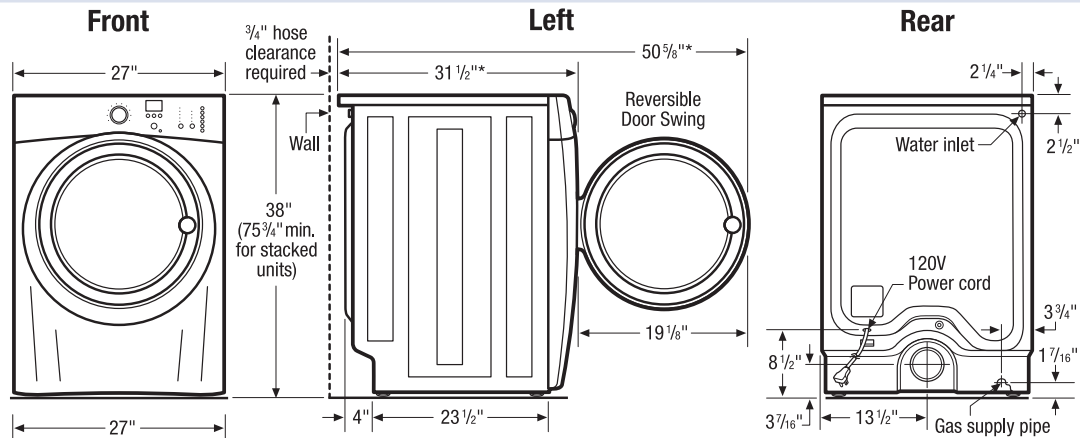

15" Drawer Pedestal Installation

Elevates dryer height to 53". For detailed pedestal installation, refer to instructions included with pedestal or on web. **Note:** Pedestal Installation requires modified utility hookup locations. For details, refer to Product Installation Guide on web.

Built-In Installations

For built-in installations, 3/4" steam hose clearance required at back of dryer, NO minimum clearance required around sides of units. For closet installation, allow 1" clearance between fronts of units and door. Location of plumbing, exhaust and utility hookups MUST be considered in built-in installations. For additional xinstallation details, refer to Product Installation Guides on web.

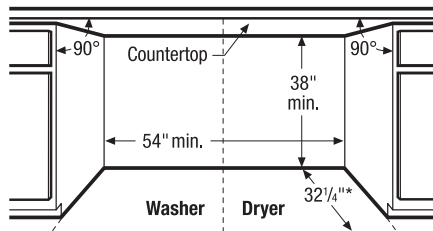

Side-by-Side Units in Under-Counter Installation

Requires custom-built countertop and/or cabinetry.

* To achieve minimal depth dimensions or clearances, dryer MUST be vented straight back or with quick-turn 90° elbow.

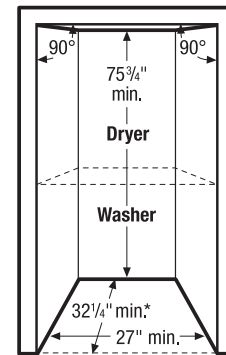

Stacked Units in Recessed or Closet Installation

For detailed stacked installation, refer to instructions included with Stacking Kit or on web. **Note:** Stacked installation requires modified utility hookup locations for dryer. For details, refer to Product Installation Guide on web.

Gas Dryer Specifications

- Product Weight – 130 Lbs.
- An electrical supply with grounded three-prong receptacle is required. The power supply circuit must be installed in accordance with current edition of National Electrical Code (ANSI/NFPA 70) and local codes & ordinances. (Do not use same circuit as washer.)
- Voltage Rating – 120V/60Hz/15 Amps
- Amps @ 120 Volts = 9 Amps
- Connected Load (kW Rating) @ 120 Volts = 1.1 kW
- Equipped with 120V 3-wire power supply cord, approx. 60" long.
- Always consult local and national electric, gas & plumbing codes.
- Can be installed alone, with or without optional 15" drawer pedestal, or stacked above matching Electrolux Washer, which requires installation of optional dryer stacking kit. (For installation details, refer to instructions included with optional pedestal or stacking kit or on web.)
- Can be built in with matching Electrolux Washer in under-counter, recessed or closet installation. Installations requiring countertop and/or cabinetry will require custom building. (Refer to Built-In Installations on this page for cutout dimensions. For additional installation details, refer to Product Installation Guide on web.)
- Closet installation requires vented door with 2 unobstructed louvered openings, minimum 60 sq.in. each, located 3" from top and bottom of door. Full-length 120 sq.in. opening also acceptable. Allow 1" clearance between door and fronts of units.
- Do NOT install in area exposed to dripping water or outdoor weather conditions, or where gasoline or other flammables, including automobiles, are kept or stored.

- Floor MUST be solid with 1" maximum slope. To ensure vibration or movement does not occur, reinforcement of floor may be necessary. Do NOT install on carpeted surface.
- Dryer MUST exhaust to outside of building, NOT into any concealed space.
- Dryer equipped for 4-way venting and approved for up to 125-foot-equivalent of duct length, determined by length of run and number of elbows needed.
- Exhaust installation requires minimum 4"-diameter rigid or semi-rigid metal duct with approved, unobstructed vent hood having swing-out damper(s). If installing rigid metal duct (preferred), do not exceed MAXIMUM venting run length of 125 ft., allow deductions for elbows and vents. If installing semi-rigid metal duct, do not exceed MAXIMUM venting run length of 8 ft., always allow deductions for elbows and vents (Refer to Product Installation Guide on web for additional information). Do NOT use flexible plastic or metal foil duct and use shortest run possible.
- Gas supply line should be 1/2" pipe and MUST have individual shutoff valve.
- Leveling legs supplied to level dryer properly and reduce excessive noise and vibration.
- Water inlet hose for steam setting connects to cold water supply with "Y" connector and requires 3/4" clearance between back of unit and wall.

Note: For planning purposes only. Refer to Product Installation Guide on the web at electroluxappliances.com for detailed instructions.

Optional Accessories

- Drawer Pedestals – Red Hot Red (PN# EPWD15RR), Mediterranean Blue (PN# EPWD15MB), Island White (PN# EPWD15IW).
- Dryer Stacking Kit – (PN# STACKIT4X).
- Mobile Home Installation Kit – (PN# 137067200).
- LP Gas Conversion Kit – (PN# PCK4200).

