



OWNER'S MANUAL

DRYER

Read this owner's manual thoroughly before operating the appliance and keep it handy for reference at all times.

ENGLISH

DF20*V2W

DF20*V2**

DF50*V2S6W

DF50*V2S6WE



MFL70442660
Rev.03_020823

www.lg.com
Copyright © 2023 LG Electronics Inc. All Rights Reserved.

TABLE OF CONTENTS

3 IMPORTANT SAFETY INSTRUCTIONS

- 3 WHAT TO DO IF YOU SMELL GAS
- 4 BASIC SAFETY PRECAUTIONS
- 5 GROUNDING INSTRUCTIONS
- 5 SAFETY INSTRUCTIONS FOR INSTALLATION
- 7 SAFETY INSTRUCTIONS FOR CONNECTING ELECTRICITY

8 PRODUCT FEATURES

9 PRODUCT OVERVIEW

- 9 Parts
- 9 Accessories

10 INSTALLATION

- 10 Installation Overview
- 10 Product Specifications
- 11 Installation Location Requirements
- 12 Clearances
- 14 Leveling the Dryer
- 15 Reversing the Door
- 16 Installing the Side Vent Kit
- 17 Stacking the Dryer
- 18 Venting the Dryer
- 20 Connecting Gas Dryers
- 22 Connecting Electric Dryers
- 26 Final Installation Check
- 27 Installation Test (Duct Check)

29 OPERATION

- 29 Using the Dryer
- 30 Check the Lint Filter Before Every Load
- 30 Sorting Loads
- 30 Loading the Dryer
- 31 Control Panel
- 33 Cycle Guide
- 35 Cycle Settings and Options

37 SMART FUNCTIONS

- 37 LG ThinQ Application

38 MAINTENANCE

- 38 Regular Cleaning

39 TROUBLESHOOTING

- 39 FAQs: Frequently Asked Questions
- 40 Before Calling for Service

IMPORTANT SAFETY INSTRUCTIONS

READ ALL INSTRUCTIONS BEFORE USE

WARNING

For your safety, the information in this manual must be followed to minimize the risk of fire, explosion, or electric shock, or to prevent property damage, injury to persons, or death.

Your safety and the safety of others is very important.

We have provided many important safety messages in this manual and on your appliance. Always read and obey all safety messages.



This is the safety alert symbol.

This symbol alerts you to potential hazards that can kill or hurt you and others.

All safety messages will follow the safety alert symbol and either the word DANGER, WARNING, or CAUTION.

These words mean:



DANGER - You will be killed or seriously injured if you don't immediately follow instructions.



WARNING - You can be killed or seriously injured if you don't follow instructions.



CAUTION - You may be slightly injured or cause damage to the product if you do not follow instructions.

All safety messages will tell you what the potential hazard is, tell you how to reduce the chance of injury, and tell you what can happen if the instructions are not followed.

- **Do not install a clothes dryer with flexible plastic venting materials. If flexible metal (foil type) duct is installed, it must be of a specific type identified by the appliance manufacturer as suitable for use with clothes dryers. Flexible venting materials are known to collapse, be easily crushed, and trap lint. These conditions will obstruct clothes dryer airflow and increase the risk of fire.**
- **Install the clothes dryer according to the manufacturer's instructions and local codes.**
- **Save these instructions.**

WARNING

FIRE OR EXPLOSION HAZARD

Failure to follow safety warnings exactly could result in serious injury, death or property damage.

- Do not store or use gasoline or other flammable vapors and liquids in the vicinity of this or any other appliance.

WHAT TO DO IF YOU SMELL GAS

- Do not try to light any appliance.
- Do not touch any electrical switch; do not use any phone in your building.
- Clear the room, building or area of all occupants.
- Immediately call your gas supplier from a neighbor's phone. Follow the gas supplier's instructions.
- If you cannot reach your gas supplier, call the fire department.
- Installation and service must be performed by a qualified installer, service agency or the gas supplier.

IMPORTANT SAFETY INSTRUCTIONS

READ ALL INSTRUCTIONS BEFORE USE



WARNING

For your safety, the information in this manual must be followed to minimize the risk of fire, explosion, or electric shock, or to prevent property damage, injury to persons, or death.

BASIC SAFETY PRECAUTIONS



WARNING

To reduce the risk of fire, electric shock, or injury to persons when using this appliance, follow basic precautions, including the following:

- Read all instructions before using the dryer.
- Before use, the dryer must be properly installed as described in this manual.
- Do not place items exposed to cooking oils in your dryer. Items contaminated with cooking oils may contribute to a chemical reaction that could cause a load to catch fire.
- Do not dry articles that have been previously cleaned in, washed in, soaked in, or spotted with gasoline, dry-cleaning solvents, or other flammable or explosive substances as they give off vapors that could ignite or explode.
- Do not reach into the dryer if the drum or any other part is moving.
- Do not repair or replace any part of the dryer or attempt any servicing unless specifically recommended in this owner's manual or in published user-repair instructions that you understand and have the skills to carry out.
- Do not tamper with controls.
- Before the dryer is removed from service or discarded, remove the door to the drying compartment.
- Do not allow children to play on or in the dryer. Close supervision of children is necessary when the dryer is used near children.
- This appliance is not intended for use by persons (including children) with reduced physical, sensory or mental capabilities, or lack of experience and knowledge, unless they have been given supervision or instruction concerning use of the appliance by a person responsible for their safety.
- Children should be supervised to ensure that they do not play with the appliance.
- Do not use fabric softeners or products to eliminate static unless recommended by the manufacturer of the fabric softener or product.
- Do not use heat to dry articles containing foam rubber or similarly textured rubber-like materials.
- Keep area around the exhaust opening and adjacent surrounding areas free from the accumulation of lint, dust, and dirt.
- It should not be operated if chemical products are used for cleaning.
- The interior of the dryer and exhaust vent should be cleaned periodically by qualified service personnel.
- Do not install or store the dryer where it will be exposed to the weather.
- Always check the inside of the dryer for foreign objects.
- Clean lint screen before or after each load.
- **Do not store plastic, paper, or clothing that may burn or melt on top of the dryer during operation.**
- Be careful when opening and closing the door. Fingers and hands can get caught in the door and cause injury if the door drops forward unexpectedly.
- **Do not place heavy items on or lean against the top of the door when it is open.**
- **Do not attempt to pull the hamper door open more than 40 degrees.**
- The dryer could tip forward, causing injury or damage.
- Do not place items on the top of the dryer.
- Certain internal parts are intentionally not grounded and may present a risk of electric shock only during servicing. Service personnel - do not contact the following parts while the appliance is energized: valve, motor, control board, heater, generator.



WARNING

Never stop a tumble dryer before the end of the drying cycle unless all items are quickly removed and spread out so that the heat is dissipated.

- Exhaust air must not be discharged into a flue which is used for exhausting fumes from appliances burning gas or other fuels.
- The appliance must not be installed behind a lockable door, a sliding door or a door with a hinge on the opposite side to that of the tumble dryer.
- Items such as foam rubber (latex foam), shower caps, waterproof textiles, rubber backed articles and clothes or pillows fitted with foam rubber pads should not be dried in the tumble dryer.

IMPORTANT SAFETY INSTRUCTIONS

READ ALL INSTRUCTIONS BEFORE USE

WARNING

For your safety, the information in this manual must be followed to minimize the risk of fire, explosion, or electric shock, or to prevent property damage, injury to persons, or death.

GROUNDING INSTRUCTIONS

This appliance must be grounded. In the event of malfunction or breakdown, grounding will reduce the risk of electric shock by providing a path of least resistance for electric current. This appliance must be equipped with a cord having an equipment-grounding conductor and a grounding plug. The plug must be plugged into an appropriate outlet that is properly installed and grounded in accordance with all local codes and ordinances.

Do not modify the plug provided with the appliance. If it will not fit the outlet, have a proper outlet installed by a qualified electrician.

This appliance must be connected to a grounded metal, permanent wiring system or an equipment-grounding conductor must be run with the circuit conductors and connected to the equipment-grounding terminal or lead on the appliance. Electric shock can result if the dryer is not properly grounded.

WARNING

Improper connection of the equipment-grounding conductor can result in a risk of electric shock. Check with a qualified electrician or service person if you are in doubt that the appliance is properly grounded.

SAFETY INSTRUCTIONS FOR INSTALLATION

WARNING

To reduce the risk of fire, electric shock, or injury to persons when using this appliance, follow basic precautions, including the following:

- **Properly ground dryer to conform with all governing codes and ordinances.** Follow details in the installation instructions. Electric shock can result if the dryer is not properly grounded.
- **Before use, the dryer must be properly installed** as described in this manual. Electric shock can result if the dryer is not properly grounded.
- **Install and store the dryer where it will not be exposed to temperatures below freezing or exposed to the weather.**
- **All repairs and servicing must be performed by an authorized servicer unless specifically recommended in this owner's manual. Use only authorized factory parts.** Failure to follow this warning can cause serious injury, fire, electric shock, or death.
- **To reduce the risk of electric shock, do not install the dryer in humid spaces.** Failure to follow this warning can cause serious injury, fire, electric shock, or death.
- **Connect to a properly rated, protected, and sized power circuit to avoid electrical overload.** Improper power circuit can melt, creating electric shock and/or fire hazard.
- **Remove all packing items and dispose of all shipping materials properly.** Failure to do so can result in death, explosion, fire, or burns.
- **Place dryer at least 18 inches above the floor for a garage installation.** Failure to do so can result in death, explosion, fire, or burns.
- **Keep all packaging from children.** Packaging material can be dangerous for children. There is a risk of suffocation.
- **Do not install near another source of heat such as a stove, cooking oven.** Failure to do so can cause deform, smoke and fire.
- **Do not place candles, smoking materials, or other flammables on top of the product.** Dripping wax, smoke, or fire can result.
- **Remove all protective vinyl film from the product.** Failure to do so can cause product damage, smoke or fire.
- Certain internal parts are intentionally not grounded and may present a risk of electric shock only during servicing. Service personnel - do not contact the following parts while the appliance is energized: valve, motor, control board, heater, generator.

IMPORTANT SAFETY INSTRUCTIONS

READ ALL INSTRUCTIONS BEFORE USE

WARNING

For your safety, the information in this manual must be followed to minimize the risk of fire, explosion, or electric shock, or to prevent property damage, injury to persons, or death.

SAFETY INSTRUCTIONS FOR INSTALLATION

WARNING

To reduce the risk of injury to persons, follow all industry recommended safety procedures including the use of long sleeved gloves and safety glasses. Failure to follow all of the safety warnings in this manual could result in property damage, injury to persons, or death.

Exhaust/Ducting:

- **Gas dryers MUST be exhausted to the outside. Adequate ventilation must be provided to prevent the return of gas flow into the room, from other appliances that burn other fuels, including open burners.** Failure to follow these instructions can result in fire or death.
- **The dryer exhaust system must be exhausted to the outside of the dwelling. If the dryer is not exhausted outdoors, some fine lint and large amounts of moisture will be expelled into the laundry area.** An accumulation of lint in any area of the home can create a health and fire hazard.
- **Use only rigid, semi-rigid, or flexible metal 4-inch diameter ductwork inside the dryer cabinet or for exhausting to the outside. Use of plastic or other combustible ductwork can cause a fire.** Punctured ductwork can cause a fire if it collapses or becomes otherwise restricted in use or during installation.
- **Ductwork is not provided with the dryer, and you should obtain the necessary ductwork locally. The end cap should have hinged dampers to prevent backdraft when the dryer is not in use.** Failure to follow these instructions can result in fire or death.
- **The exhaust duct must be 4 inches (10.2 cm) in diameter with no obstructions. The exhaust duct should be kept as short as possible. Make sure to clean any old ducts before installing your new dryer.** Failure to follow these instructions can result in fire or death.
- Fabric softeners, or similar products, should be used as specified by the fabric softener instructions.
- Remove all objects from pockets such as lighters and matches.
- **Rigid, semi-rigid, or flexible metal ducting is recommended for use between the dryer and the wall. All non-rigid metal transition duct must be UL-listed. Use of other materials for transition ducting could affect drying time.** Failure to follow these instructions can result in fire or death.
- **DO NOT use sheet metal screws or other fasteners which extend into the duct that could catch lint and reduce the efficiency of the exhaust system.** Secure all joints with duct tape. For complete details, follow the Installation Instructions. Failure to follow these instructions can result in fire or death.

WARNING

Fire Hazard

Failure to follow safety warnings exactly could result in serious injury, death or property damage. Do not install a booster fan in the exhaust duct. Install all clothes dryers in accordance with the installation instructions of the manufacturer of the dryer.

WARNING

Never stop a tumble dryer before the end of the drying cycle unless all items are quickly removed and spread out so that the heat is dissipated.

- a. For appliances with ventilation openings in the base, that a carpet must not obstruct the openings.
- b. Exhaust air must not be discharged into a flue which is used for exhausting fumes from appliances burning gas or other fuels.

IMPORTANT SAFETY INSTRUCTIONS

READ ALL INSTRUCTIONS BEFORE USE



WARNING

For your safety, the information in this manual must be followed to minimize the risk of fire, explosion, or electric shock, or to prevent property damage, injury to persons, or death.

SAFETY INSTRUCTIONS FOR CONNECTING ELECTRICITY



WARNING

To reduce the risk of fire, electric shock, or injury to persons when using this appliance, follow basic precautions, including the following:

- **Do not, under any circumstances, cut or remove the ground prong from the power cord.** To prevent injury to persons or damage to the dryer, the electrical power cord must be plugged into a properly grounded outlet.
- **For personal safety, this dryer must be properly grounded.** Failure to do so can result in electric shock or injury.
- **Refer to the installation instructions in this manual for specific electrical requirements for your model.** Failure to follow these instructions can create an electric shock hazard and/or a fire hazard.
- **This dryer must be plugged into a properly grounded outlet. Electric shock can result if the dryer is not properly grounded. Have the wall outlet and circuit checked by a qualified electrician to make sure the outlet is properly grounded.** Failure to follow these instructions can create an electric shock hazard and/or a fire hazard.
- If the supply cord is damaged, it must be replaced by the manufacturer, its service agent or similarly qualified persons in order to avoid a hazard.
- **The dryer should always be plugged into its own individual electrical outlet which has a voltage rating that matches the rating plate.** This provides sparkling performance and also prevents overloading house wiring circuits which could cause a fire hazard from overheated wires.
- **Never unplug your dryer by pulling on the power cord. Always grip plug firmly and pull straight out from the outlet.** The power cord can be damaged, resulting in a risk of fire and electric shock.
- **Repair or replace immediately all power cords that have become frayed or otherwise damaged. Do not use a cord that shows cracks or abrasion damage along its length or at either end.** The power cord can melt, creating an electric shock and/or fire hazard.
- **When installing or moving the dryer, be careful not to pinch, crush, or damage the power cord.** This will prevent injury and prevent damage to the dryer from fire and electric shock.

SAVE THESE INSTRUCTIONS

PRODUCT FEATURES

EASY-TO-USE CONTROL PANEL

Rotate the cycle selector knob to select the desired dry cycle. Add cycle options or adjust settings with the touch of a button.

EASY-ACCESS REVERSIBLE DOOR

The wide-opening door provides easy access for loading and unloading. The door hinge can be reversed to adjust for installation location.

Flow Sense™ DUCT BLOCKAGE SENSING SYSTEM INDICATOR

The Flow Sense™ duct blockage sensing system detects and alerts you to restrictions in the installed household ductwork that reduce exhaust airflow through the dryer. If you see the alert: Clean or repair the ducts to remove the restrictions. Keep your ducts clean to help increase efficiency and reduce long drying times caused by blocked ducts.

Smart Diagnosis™

Should you experience any technical difficulty with your washing machine, it has the capability of transmitting data by phone to the Customer Information Center. The call center agent records the data transmitted from your machine and uses it to analyze the issue, providing a fast and effective diagnosis.

PRODUCT OVERVIEW

Parts

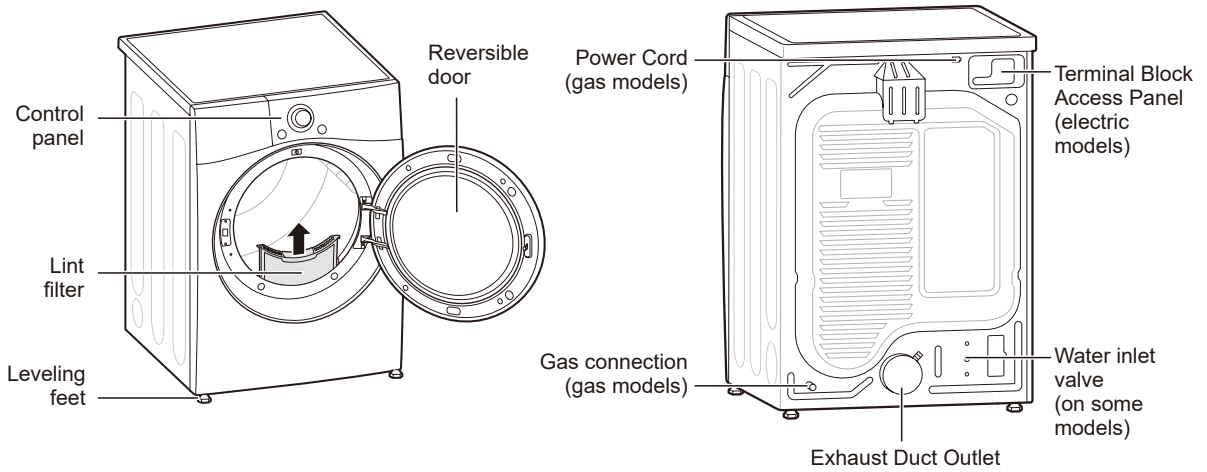

Accessories

Included Accessories

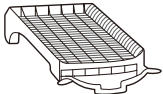

Drying Rack
(on some models)

Optional Accessories (sold separately)

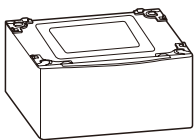

Pedestal

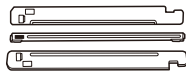

Stacking kit

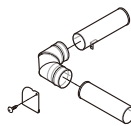

Side vent kit
Kit No. 383EEL9001B

NOTE

- For your safety and for extended product life, use only authorized components. The manufacturer is not responsible for product malfunction or accidents caused by the use of separately purchased unauthorized components or parts.
- The images in this guide may be different from the actual components and accessories, which are subject to change by the manufacturer without prior notice for product improvement purposes.

INSTALLATION

Installation Overview

Please read the following installation instructions first after purchasing this product or transporting it to another location.

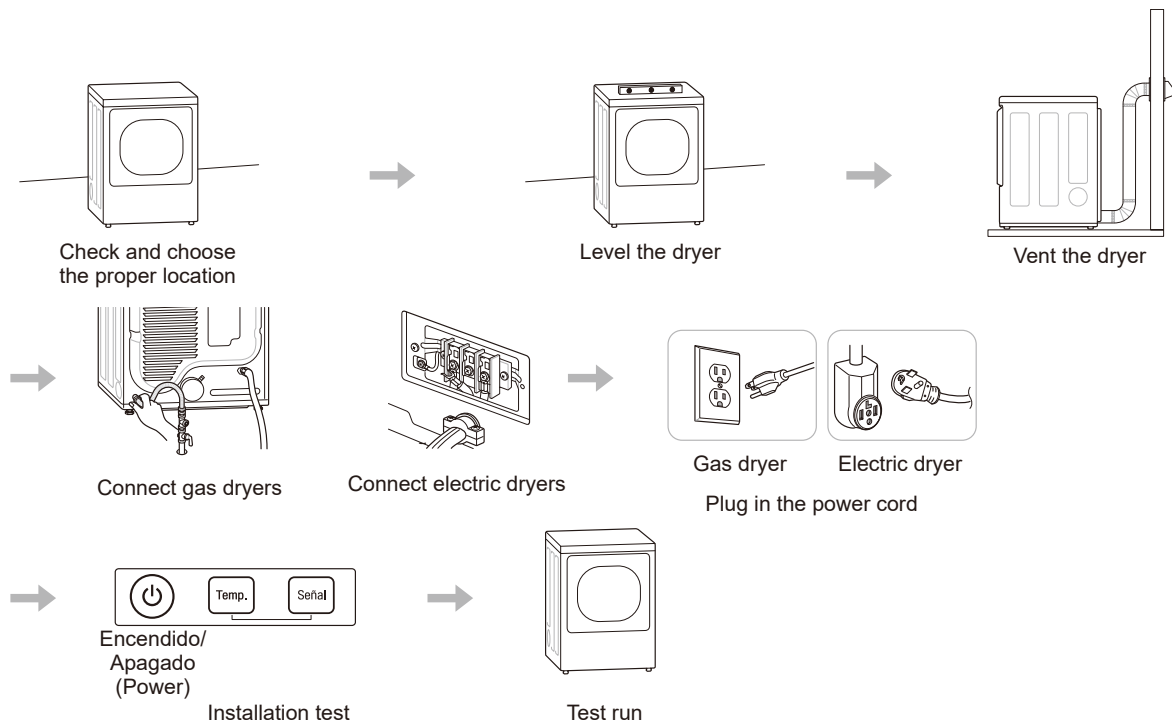

Product Specifications

The appearance and specifications listed in this manual may vary due to constant product improvements.

Dryer Models	DF20*V2W / DF20*V2** / DF50*V2S6W / DF50*V2S6WE	
Description	Non-steam Dryer	
Electrical requirements	Gas : 120 V~ 60 Hz 400 W Elec : 120/240 V~ 60 Hz 5550 W	
Gas requirements	NG: 4 - 10.5-inch (10.2 - 26.7 cm) WC LP: 8 - 13-inch (20.4 - 33.1 cm) WC	
Dimensions	27" (W) X 30.2" (D) X 39" (H), 51.4" (D with door open) 68.6 cm (W) X 76.5 cm (D) X 99 cm (H), 130.5 cm (D with door open)	
Net weight	Gas : 120.81 lb (54.8kg) Electric : 118.61 lb (53.8kg)	
Drying capacity	Normal Cycle	IEC 7.4 cu.ft. (22.5 lb/10.2 kg)
Drum capacity	210 L	

NOTE

Model numbers can be found on the cabinet inside the door.

Installation Location Requirements



WARNING

Read all installation instructions completely before installing and operating the dryer! It is important that you review this entire manual before installing and using the dryer. Detailed instructions concerning electrical connections, gas connections, and exhaust requirements are provided on the following pages.

The installation requires:

- A location that allows for proper exhaust installation. A gas dryer must be exhausted to the outdoors. See Venting the Dryer.
- A grounded electrical outlet located within 2 ft. (61 cm) of either side of the dryer. See Connecting Electric Dryers .
- A sturdy floor to support the total dryer weight of 200 lb (90.7 kg). The combined weight of a companion appliance should also be considered.
- No other fuel-burning appliance can be installed in the same closet as a dryer.

Do not operate the dryer at temperatures below 45 °F (7 °C). At lower temperatures, the dryer might not shut off at the end of an automatic cycle. This can result in longer drying times. The dryer must not be installed or stored in an area where it will be exposed to water and/or weather. Check code requirements. Some codes limit, or do not permit, installation of the dryer in garages, mobile homes or sleeping quarters. Contact your local building inspector.

NOTE

- The floor must be level, with a maximum slope of 1 inch (2.5 cm) under the entire dryer. Clothes may not tumble properly, and automatic sensor cycles may not operate correctly if dryer is not level.
- For a garage installation, you will need to place the dryer at least 18 inches (46 cm) above the floor. The standard pedestal is 15 inches (38.1 cm). You will need 18 inches (46 cm) from the garage floor to the bottom of the dryer.

Clearances

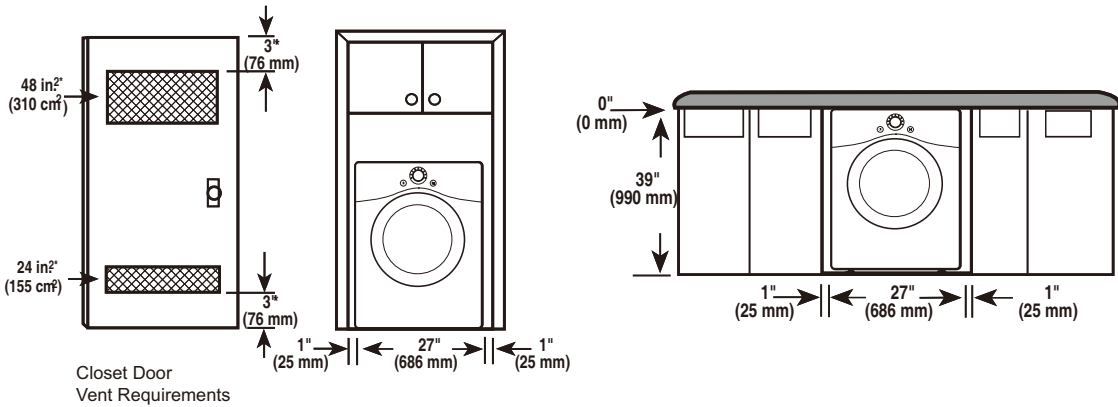
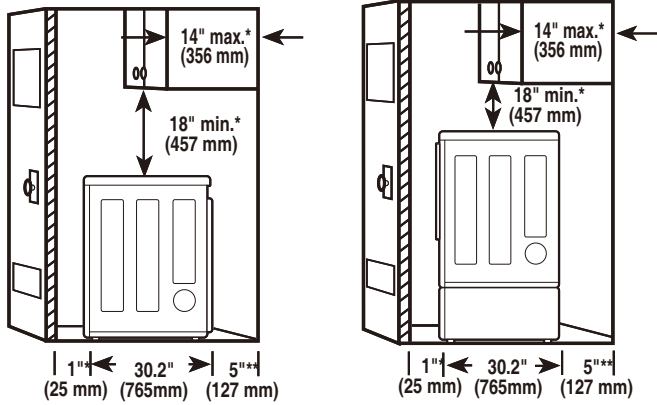

Installation Spacing for Recessed Area or Closet Installation

The following spacing dimensions are recommended for this dryer. This dryer has been tested for clearances of 1 inch (2.5 cm) on the sides and rear. Recommended clearances should be considered for the following reasons:

- Additional clearances should be considered for ease of installation and servicing.
- Additional clearances might be required for wall, door and floor moldings.
- Additional clearances should be considered on all sides of the dryer to reduce noise transfer.
For closet installation, with a door, minimum ventilation openings in the top and bottom of the door are required. Louvered doors with equivalent ventilation openings are acceptable.
- Companion appliance spacing should also be considered.

Closet Ventilation Requirements

Closets with doors must have both an upper and lower vent to prevent heat and moisture buildup in the closet. One upper vent opening with a minimum opening of 48 sq. in. (310 cm²) must be installed no lower than 6 feet above the floor. One lower vent opening with a minimum opening of 24 sq. in. (155 cm²) must be installed no more than one foot above the floor. Install vent grills in the door or cut down the door at the top and bottom to form openings. Louvered doors with equivalent ventilation openings are also acceptable.

NOTE

There should be at least a little space around the dryer (or any other appliance) to eliminate the transfer of vibration from one appliance to another. If there is enough vibration, it could cause appliances to make noise or come into contact, causing paint damage and further increasing noise.

Installation Spacing for Recessed Area or Closet, with Stacked Washer and Dryer

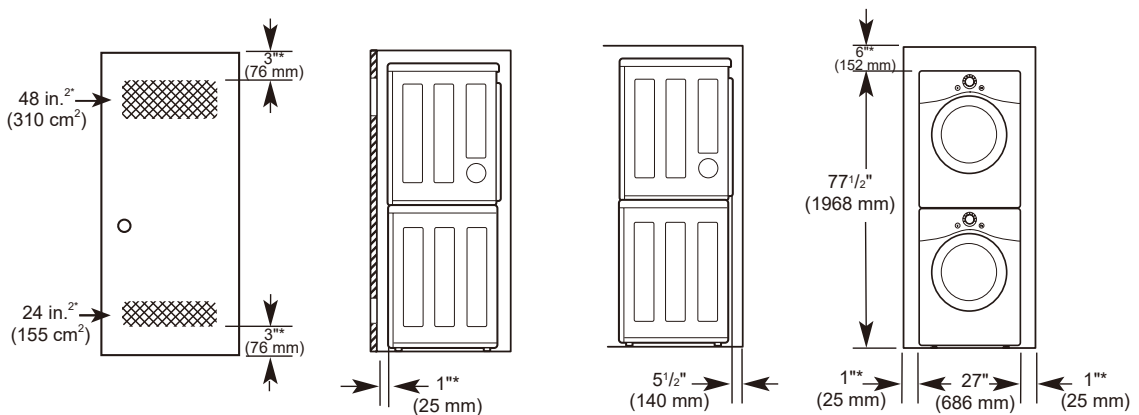

* Required spacing

** For side or bottom venting, 2-inch (5.1 cm) of spacing is allowed.

Installation Spacing for Cabinet

For cabinet installation with a door, minimum ventilation openings in the top of the cabinet are required.

* Required spacing

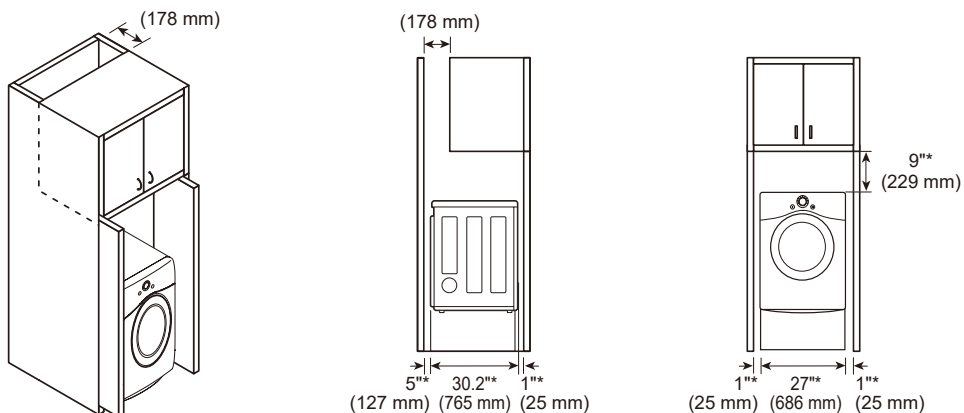

Leveling the Dryer

WARNING

To reduce the risk of injury to persons, adhere to all industry recommended safety procedures including the use of long-sleeved gloves and safety glasses. Failure to follow this warning may result in serious injury or death.

- The appliance is heavy. Two or more people are required when installing the dryer. Failure to follow this warning may result in serious injury or death.
- To ensure that the dryer provides optimal drying performance, it must be level. To minimize vibration, noise, and unwanted movement, the floor must be a perfectly level, solid surface.

NOTE

Adjust the leveling feet only as far as necessary to level the dryer. Extending the leveling feet more than necessary may cause the dryer to vibrate.

- 1 Position the dryer in the final location. Check levelness of dryer from side to side. Repeat from front to back.

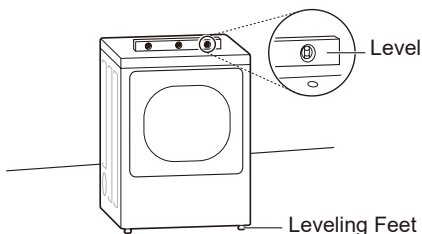

- All four leveling feet must rest solidly on the floor. Gently push on the top corners of the dryer to make sure that the dryer does not rock from corner to corner.

- 2 Use an adjustable wrench to turn the leveling feet. Unscrew the legs to raise the dryer or screw in the legs to lower it. Raise or lower with the leveling feet until the dryer is level from side to side and front to back. Make sure that all four leveling feet are in firm contact with the floor.

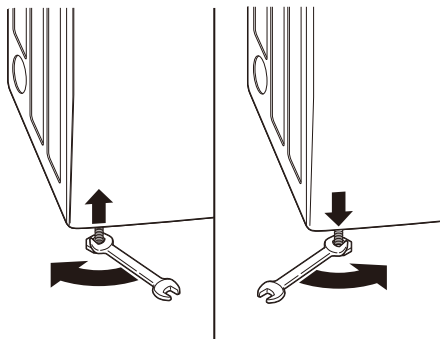

If you are installing the dryer on the optional pedestal, you must use the leveling feet on the pedestal to level the dryer. The dryer leveling feet should be fully retracted.

Reversing the Door

Tools Required

Phillips or large flat-blade screwdriver (for hinge screws)
Small flat-blade screwdriver (for lifting out parts)

WARNING

The dryer door is very large and heavy.

Failure to follow the instructions below can result in damage to the dryer, property damage or personal injury.

- To avoid damage to the dryer or the door, support the door with a stool or box that fits under the door, or have an assistant support the weight of the door.
- Avoid dropping the door to prevent damage to the door or the floor.
- Unplug the dryer or turn off power at the main circuit breaker before beginning door reversal.
- Always reverse the door BEFORE stacking the dryer on top of the washer.

Door Reversal Instructions

NOTE

The instructions here are for changing the door swing from a right to a left side hinge. If the door has been reversed, and it is necessary to change it back, use care when following these instructions.

Some of the illustrations and the left/right references will be reversed, and you will need to read the instructions carefully.

- 1 Open the door and remove the two decorative screws, two latch screws, and the latch on the catch side with a screwdriver. Save these for step 4.

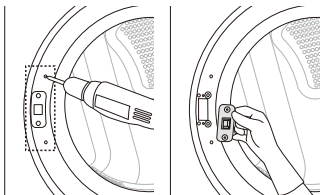

- 2 While supporting the door, remove the 2 screws on the door hinge. Remove the door.

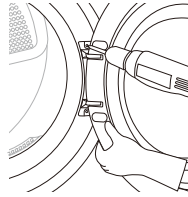

- 3 Turn the door upside down and line up the holes in the hinge with the holes on the opposite side of the cabinet. Reinstall the door with the screws removed in step 2.

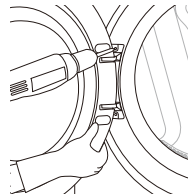

WARNING

- Be sure to support the weight of the door before installing the hinge screws.

- 4 Install the two decorative screws, the latch, and two latch screws removed in step 1 on the opposite side from which they were removed.

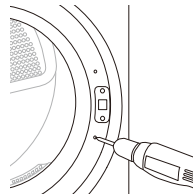

- 5 Check that the door closes properly.

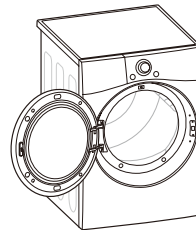

Installing the Side Vent Kit

⚠ WARNING

- Use a heavy metal vent.
- Do not use plastic or thin foil ducts.
- Clean old ducts before installing this dryer.
- To reduce the risk of injury to persons, adhere to all industry recommended safety procedures including the use of long-sleeved gloves and safety glasses.
- Failure to follow all of the safety warnings in this manual could result in property damage, injury to persons, or death.

The dryer is shipped to vent to the rear. It can also be configured to vent to the bottom or side (right-side venting is not available on gas models).

An adapter kit, part number 383EEL9001B, may be purchased from an LG retailer. This kit contains the necessary duct components to change the dryer vent location.

- 1 Remove the rear exhaust duct retaining screw. Pull out the exhaust duct.

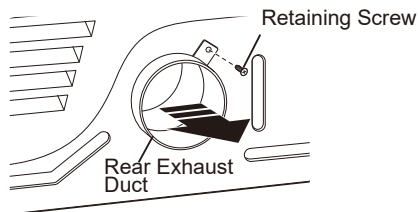

Option 1: Side Venting

- 2 Press the tabs on the knockout and carefully remove the knockout for the desired vent opening (right-side venting is not available on gas models). Press the adapter duct onto the blower housing and secure to the base of the dryer as shown.

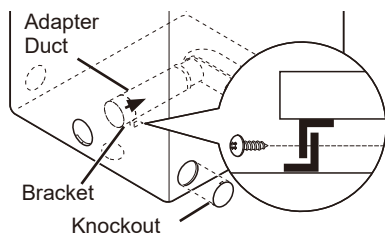

- 3 Preassemble a 4-inch (10.2 cm) elbow to the next 4-inch (10.2 cm) duct section, and secure all joints with duct tape. Be sure that the male end of the elbow faces AWAY from the dryer. Insert the elbow/duct assembly through the side opening and press it onto the adapter duct. Secure it in place with duct tape. Be sure that the male end of the duct protrudes 1½ inches (3.8 cm) to connect the remaining ductwork. Attach the cover plate to the back of the dryer with the included screw.

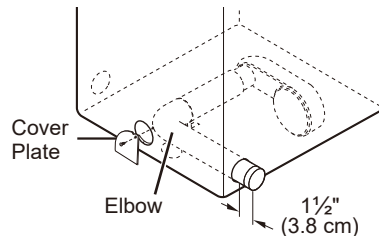

Option 2: Bottom Venting

- 2 Press the adapter duct onto the blower housing and secure it to the base of the dryer as shown.

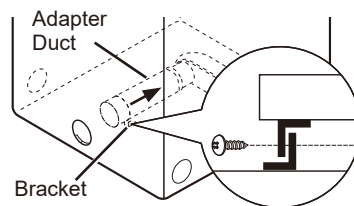

- 3 Insert the 4-inch (10.2 cm) elbow through the rear opening and press it onto the adapter duct. Be sure that the male end of the elbow faces down through the hole in the bottom of the dryer. Secure it in place with duct tape. Attach the cover plate to the back of the dryer with the included screw.

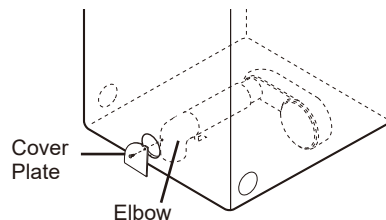

Stacking the Dryer

Stacking Kit Installation

This stacking kit includes:

- Two (2) side rails
- One (1) front rail
- Four (4) screws

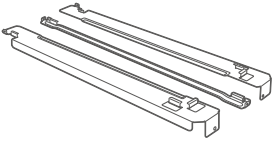

Tools Needed for Installation:

- Phillips screwdriver



WARNING

To reduce the risk of electrical shock, fire, explosion, property damage, serious injury or death, follow basic precautions, including the following:

- The weight of the dryer and the height of installation make this stacking procedure too risky for one person. Two or more people are required when installing the stacking kit.
- Do not use the stacking kit with a gas dryer in potentially unstable conditions such as a mobile home.
- Place the washer on a solid, stable, level floor capable of supporting the weight of both appliances.
- Do not stack the washer on top of the dryer.
- If appliances are already installed, disconnect them from all power, water, or gas lines and from draining or venting connections.

To ensure safe and secure installation, please observe the following instructions.

- 1 Make sure the surface of the washer is clean and dry. Remove paper backing from the tape on one of the stacking kit side brackets.

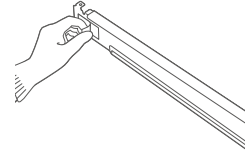

- 2 Fit the side bracket to the side of the washer top as shown in the below illustration. Firmly press the adhesive area of the bracket to the washer surface. Secure the side bracket to the washer with a screw on the back side of the bracket. Repeat steps 1 and 2 to attach the other side bracket.

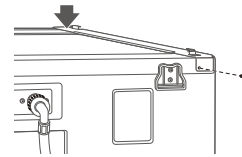

- 3 Place the dryer on top of the washer, fitting the dryer feet into the side brackets as illustrated. Avoid finger injuries; do not allow fingers to be pinched between the washer and dryer. Slowly slide the dryer toward the back of the washer until the side bracket stoppers catch the dryer feet.

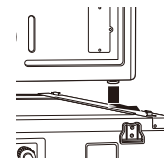

- 4 Insert the front rail between the bottom of the dryer and the top of the washer. Push the front rail toward the back of the washer until it comes in contact with the side rail stoppers.

Install the two remaining screws to secure the front rail to the side rails.

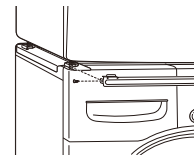

Venting the Dryer



WARNING

To reduce the risk of fire or explosion, electric shock, property damage, injury to persons or death when using this appliance, follow basic safety precautions, including the following:

- **Do not crush or collapse ductwork.** Failure to follow these instructions may result in fire or death.
- **Do not allow ductwork to rest on or contact sharp objects.** Failure to follow these instructions may result in fire or death.
- **If connecting to existing ductwork, make sure it is suitable and clean before installing the dryer.** Failure to follow these instructions may result in fire or death.
- **Venting must conform to local building codes.** Failure to follow these instructions may result in fire or death.
- **Gas dryers MUST exhaust to the outdoors.** Failure to follow these instructions may result in fire or death.
- **Use only 4-inch (10.2 cm) rigid, semi-rigid or flexible metal ductwork inside the dryer cabinet and for venting outside.** Failure to follow these instructions may result in fire or death.
- **To reduce the risk of fire, combustion, or accumulation of combustible gases, DO NOT exhaust dryer air into an enclosed and unventilated area, such as an attic, wall, ceiling, crawl space, chimney, gas vent, or concealed space of a building.** Failure to follow these instructions may result in fire or death.
- **To reduce the risk of fire, DO NOT exhaust the dryer with plastic or thin foil ducting.** Failure to follow these instructions may result in fire or death.
- **The exhaust duct must be 4 inches (10.2 cm) in diameter with no obstructions. The exhaust duct should be kept as short as possible. Make sure to clean any old ducts before installing your new dryer.** Failure to follow these instructions may result in fire or death.
- **Rigid, semi-rigid or flexible metal ducting is recommended for use between the dryer and the wall. All non-rigid metal transition duct must be UL-listed. Use of other materials for transition duct could affect drying time.** Failure to follow these instructions may result in fire or death.

- **DO NOT use sheet metal screws or other fasteners which extend into the duct that could catch lint and reduce the efficiency of the exhaust system. Secure all joints with duct tape.** Failure to follow these instructions may result in fire or death.
- **Do not exceed the recommended duct length limitations noted in the chart.** Failure to follow these instructions may result in extended drying times, fire or death.
- **Ductwork is not provided with the dryer. You should obtain the necessary ductwork locally. The vent hood should have hinged dampers to prevent backdraft when the dryer is not in use.** Failure to follow these instructions may result in fire or death.
- **The total length of flexible metal duct must not exceed 8 ft. (2.4 m).**
- **In Canada, only those foil-type flexible ducts, if any, specifically identified for use with the appliance by the manufacturer should be used.** In the United States, only those foil-type flexible ducts, if any, specifically identified for use with the appliance by the manufacturer and that comply with the Outline for Clothes Dryer Transition Duct, Subject 2158A, should be used.

Ductwork

Wall Cap Type	Number of 90° Elbows	Maximum length of 4-inch (10.2 cm) diameter rigid metal duct
 Recommended	0	65 ft.(19.8 m)
	1	55 ft.(16.8 m)
	2	47 ft.(14.3 m)
	3	36 ft.(11.0 m)
	4	28 ft.(8.5 m)
 Use only for short run installations	0	55 ft.(16.8 m)
	1	47 ft.(14.3 m)
	2	41 ft.(12.5 m)
	3	30 ft.(9.1 m)
	4	22 ft.(6.7 m)

NOTE

Deduct 6 ft. (1.8 m) for each additional elbow. Do not use more than four 90° elbows.

Routing And Connecting Ductwork

NOTE

Follow the guidelines below to maximize drying performance and reduce lint buildup and condensation in the ductwork. Ductwork and fittings are NOT included and must be purchased separately.

- Use 4-inch (10.2 cm) diameter rigid, semi-rigid or flexible metal ductwork.
- The exhaust duct run should be as short as possible.
- Use as few elbow joints as possible.
- The male end of each section of exhaust duct must point away from the dryer.
- Use duct tape on all duct joints.
- Insulate ductwork that runs through unheated areas in order to reduce condensation and lint buildup on duct surfaces.
- Incorrect or inadequate exhaust systems are not covered by the dryer warranty. Dryer failures or service required because of such exhaust systems will not be covered by the dryer warranty.

Correct Venting

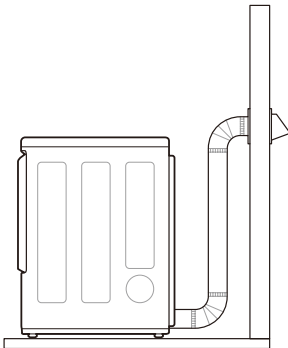

Incorrect Venting

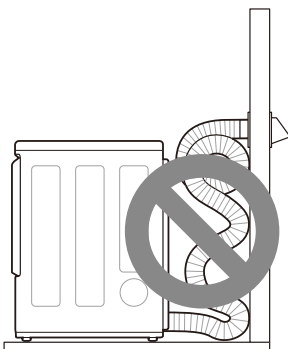

Connecting Gas Dryers

WARNING

To reduce the risk of fire or explosion, electric shock, property damage, injury to persons, or death when using this appliance, follow basic safety precautions.

Gas Supply Requirements

- **As shipped from the factory, this dryer is configured for use with propane (LP). It can be converted for use with natural (NG) gas. Gas pressure must not exceed 8 inches (20.3 cm) of water column for NG, or 13 inches (33 cm) of water column for LP.**
- **A qualified service or gas company technician must connect the dryer to the gas service. Failure to follow these instructions may result in fire, explosion, or death.**
- **Isolate the dryer from the gas supply system by closing its individual manual shutoff valve during any pressure testing of the gas supply. Failure to do so may result in fire, explosion, or death.**
- **Supply line requirements: Your laundry room must have a rigid gas supply line to the dryer. In the United States, an individual manual shutoff valve MUST be installed within at least 6 ft. (1.8 m) of the dryer, in accordance with the National Fuel Gas Code ANSI Z223.1 or Canadian gas installation code CSA B149.1. A 1/8-inch (0.3 cm) NPT pipe plug must be installed. Failure to do so may result in fire, explosion, or death.**
- **If using a rigid pipe, the rigid pipe should be 1/2 inch IPS. If acceptable under local codes and ordinances and when acceptable to your gas supplier, 3/8-inch (1 cm) approved tubing may be used where lengths are less than 20 ft. (6.1 m). Larger tubing should be used for lengths in excess of 20 ft. (6.1 m). Failure to do so may result in fire, explosion, or death.**
- **Connect the dryer to the type of gas shown on the nameplate. Failure to do so may result in fire, explosion, or death.**
- **To prevent contamination of the gas valve, purge the gas supply of air and sediment before connecting the gas supply to the dryer. Before tightening the connection between the gas supply and the dryer, purge remaining air until the odor of gas is detected. Failure to do so may result in fire, explosion, or death.**

- **DO NOT use an open flame to inspect for gas leaks. Use a noncorrosive leak detection fluid.** Failure to do so may result in fire, explosion, or death.
- **Use only a new AGA- or CSA-certified gas supply line with flexible stainless steel connectors.** Failure to do so may result in fire, explosion, or death.
- **Securely tighten all gas connections.** Failure to do so may result in fire, explosion, or death.
- **Use Teflon tape or a pipe-joint compound that is insoluble in propane (LP) gas on all pipe threads.** Failure to do so may result in fire, explosion, or death.
- **DO NOT attempt any disassembly of the dryer; disassembly requires the attention and tools of an authorized and qualified service technician or company.** Failure to follow this warning may result in fire, explosion, or death.

Electrical Requirements for Gas Models Only

- **Do not, under any circumstances, cut or remove the third (ground) prong from the power cord.** Failure to follow this warning may result in fire, explosion, or death.
- **For personal safety, this dryer must be properly grounded.** Failure to follow this warning may result in fire, explosion, or death.
- **This dryer must be plugged into a 120 V~60 Hz grounded outlet protected by a 15-ampere fuse or circuit breaker.** Failure to follow this warning may result in fire, explosion, or death.
- **Where a standard 2-prong wall outlet is encountered, it is your personal responsibility and obligation to have it replaced with a properly grounded 3-prong wall outlet.** Failure to follow this warning may result in fire, explosion, or death.

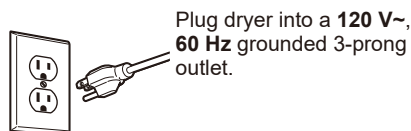

WARNING

ELECTRIC SHOCK HAZARD

Failure to follow safety warnings could result in serious injury or death.

This dryer is equipped with a three-prong grounding plug for protection against shock hazard and should be plugged directly into a properly grounded three-prong receptacle. Do not cut or remove the grounding prong from this plug.

Connecting the Gas Supply

- **Installation and service must be performed by a qualified installer, service agency, or the gas supplier.** Failure to do so may result in fire, explosion, or death.
- **Use only a new stainless steel flexible connector and a new AGA-certified connector.** Failure to do so may result in fire, explosion, or death.
- **A gas shutoff valve must be installed within 6 ft. (1.8 m) of the dryer.** Failure to do so may result in fire, explosion, or death.
- **The dryer is configured for LP gas when shipped from the factory. Make sure that the dryer is equipped with the correct burner nozzle for the type of gas being used (natural gas or propane gas).** Failure to do so may result in fire, explosion, or death.
- **If necessary, the correct nozzle (for the Natural nozzle kit, order part number 383EEL3002K) should be installed by a qualified technician and the change should be noted on the dryer.** Failure to do so may result in fire, explosion, or death.
- **All connections must be in accordance with local codes and regulations.** Failure to do so may result in fire, explosion, or death.
- **Gas dryers MUST exhaust to the outdoors.** Failure to do so may result in fire, explosion, or death.

NOTE

This dryer is configured from the factory for propane (LP). If the dryer is to be used with natural gas (NG) gas, it must be converted by a qualified service technician.

- 1 Make sure that the gas supply to the laundry room is turned OFF and the dryer is unplugged. Confirm that the type of gas available in your laundry room is appropriate for the dryer.
- 2 Remove the shipping cap from the gas fitting at the back of the dryer. Be careful not to damage the threads of the gas connector when removing the shipping cap.
- 3 Connect the dryer to your laundry room's gas supply using a new flexible stainless steel connector with a 3/8-inch NPT fitting.

NOTE

DO NOT use old connectors.

- 4 Securely tighten all connections between the dryer and your laundry room's gas supply.
- 5 Turn on your laundry room's gas supply.
- 6 Check all pipe connections (both internal and external) for gas leaks with a noncorrosive leak-detection fluid.
- 7 Proceed to Venting the Dryer.

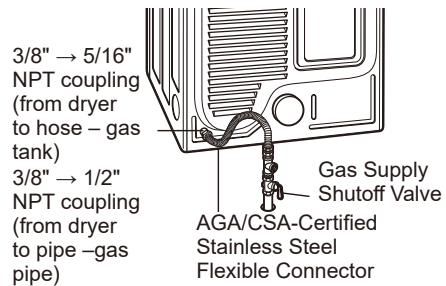

High-Altitude Installations

The BTU rating of this dryer is AGA-certified for elevations below 10,000 feet.

If your gas dryer is being installed at an elevation above 10,000 feet, it must be derated by a qualified technician or gas supplier.

Connecting Electric Dryers

Electrical Requirements for Electric Models Only



WARNING

To help prevent fire, electric shock, serious injury, or death, the wiring and grounding must conform to the latest edition of the National Electrical Code, ANSI/NFPA 70 and all applicable local regulations. Please contact a qualified electrician to check your home's wiring and fuses to ensure that your home has adequate electrical power to operate the dryer.

- **This dryer must be connected to a grounded metal, permanent wiring system, or an equipment-grounding conductor must be run with the circuit conductors and connected to the equipment-grounding terminal or lead on the dryer.** Failure to do so may result in fire, explosion, or death.
- **The dryer has its own terminal block that must be connected to a separate 240 V~, 60 Hertz, single-phase circuit, fused at 30 amperes (the circuit must be fused on both sides of the line). ELECTRICAL SERVICE FOR THE DRYER SHOULD BE OF THE MAXIMUM RATE VOLTAGE LISTED ON THE NAMEPLATE. DO NOT CONNECT THE DRYER TO 110-, 115-, OR 120-VOLT CIRCUIT.** Failure to follow these instructions may result in fire, explosion, or death.
- **If the branch circuit to dryer is 15 ft. (4.5 m) or less in length, use UL (Underwriters Laboratories) listed No. 10 AWG wire (copper wire only), or as required by local codes. If over 15 ft. (4.5 m), use UL-listed No. 8 AWG wire (copper wire only), or as required by local codes. Allow sufficient slack in wiring so the dryer can be moved from its normal location when necessary.** Failure to do so may result in fire, explosion, or death.
- **The power cord (pigtail) connection between the wall receptacle and the dryer terminal block IS NOT supplied with the dryer. Type of pigtail and gauge of wire must conform to local codes and with instructions on the following pages.** Failure to follow these instructions may result in fire, explosion, or death.
- Do not modify the plug and internal wire provided with the dryer.
- The dryer should be connected to a 4-hole outlet.
- If the plug does not fit the outlet, a proper outlet will need to be installed by a qualified electrician.

WARNING

Connect the power cord to the terminal block. Connect each wire in the power cord to the terminal block screw with the matching colored wire. The terminal block wire colors are indicated in the manual. Failure to follow these instructions may result in a short or overload.

Grounding through the neutral conductor is prohibited for: (1) new branch-circuit installations, (2) areas where local codes prohibit grounding through the neutral conductor.

Four-Wire Power Cord

- A UL-listed strain relief is required.
- Use a 30-amp, 240-volt, 4-wire, UL-listed power cord with #10 AWG-minimum copper conductor and closed loop or forked terminals with upturned ends.

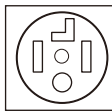

- 1 Remove the terminal block access cover on the upper back of the dryer.
- 2 Install a UL-listed strain relief into the power cord through-hole.
- 3 Thread a 30 A / 240 V~, 4-wire, UL-listed power cord with #10 AWG-minimum copper conductor through the strain relief.

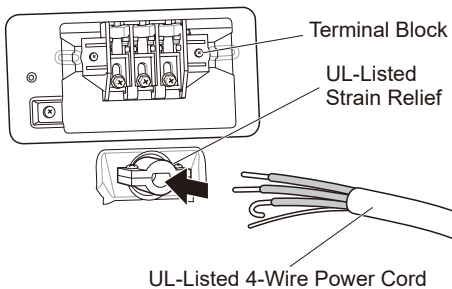

- 4 Transfer the dryer's ground wire from behind the green ground screw to the center screw of the terminal block.

NOTE

This dryer is supplied with the neutral wire grounded. This white ground wire **MUST BE MOVED** to the neutral terminal when a 4-wire cord is to be used, or where grounding through the neutral conductor is prohibited.

- 5 Attach the two hot leads of the power cord to the outer terminal block screws.
- 6 Attach the white neutral wire to the center screw of the terminal block.

- 7 Attach the power cord ground wire to the green ground screw.
- 8 Tighten all screws securely.
- 9 Reinstall the terminal block access cover.

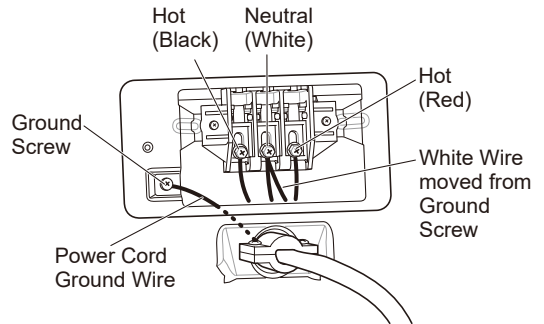

Four-Wire Direct Wire

- A UL-listed strain relief is required.
- Use UL-listed 4-wire #10 AWG-minimum copper conductor cable. Allow at least 5 ft. (1.5 m) of wire to allow for removal and reinstallation of the dryer.

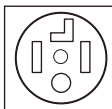

- 1 Remove 5 inches (12.7 cm) of the outer covering from the wire. Remove 5 inches (12.7 cm) of insulation from the ground wire. Cut off approximately 1½ inches (3.8 cm) from the other three wires and strip 1 inch (2.5 cm) of insulation from each wire. Bend the ends of the three shorter wires into a hook shape.

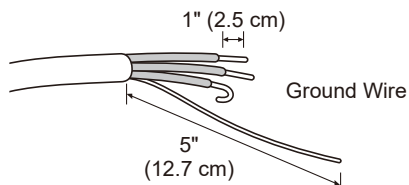

- 2 Remove the terminal block access cover on the upper back of the dryer.
- 3 Install a UL-listed strain relief into the power cord through-hole.
- 4 Thread the 4-wire #10 AWG-minimum copper power cable prepared in step 1 through the strain relief.

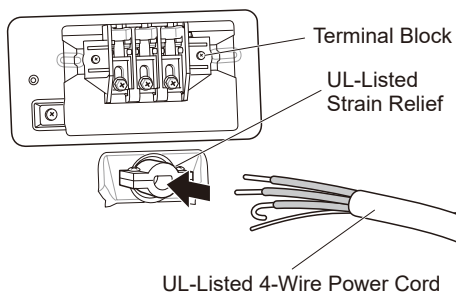

- 5 Transfer the dryer's ground wire from behind the green ground screw to the center screw of the terminal block.

NOTE

This dryer is supplied with the neutral wire grounded. This white ground wire **MUST BE MOVED** to the neutral terminal when a 4-wire cord is to be used, or where grounding through the neutral conductor is prohibited.

- 6 Attach the two hot leads of the power cord to the outer terminal block screws.

- 7 Attach the white neutral wire to the center screw of the terminal block.
- 8 Attach the power cord ground wire to the green ground screw.
- 9 Tighten all screws securely.
- 10 Reinstall the terminal block access cover.

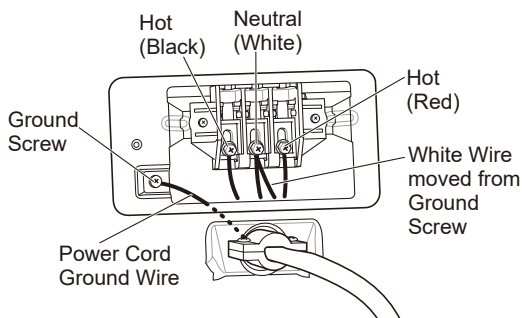

WARNING

Connect the power cord to the terminal block. Connect each wire in the power cord to the terminal block screw with the matching colored wire. The terminal block wire colors are indicated in the manual. Failure to follow these instructions may result in a short or overload.

Grounding through the neutral conductor is prohibited for: (1) new branch-circuit installations, (2) areas where local codes prohibit grounding through the neutral conductor.

Three-Wire Power Cord

- A 3-wire connection is NOT permitted on new construction after January 1, 1996.
- A UL-listed strain relief is required.
- Use a 30A / 240V~, 3-wire, UL-listed power cord with #10 AWG-minimum copper conductor and closed loop or forked terminals with upturned ends.



- 1 Remove the terminal block access cover on the upper back of the dryer.
- 2 Install a UL-listed strain relief into the power cord through-hole.
- 3 Thread a 30A / 240V~, 3-wire, UL-listed power cord with #10 AWG-minimum copper conductor through the strain relief.

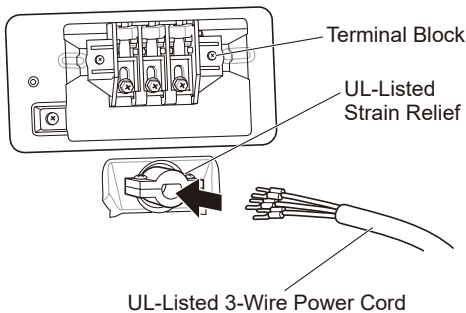

- 4 Attach the two hot leads (black and red) of the power cord to the outer terminal block screws.

- 5 Attach the neutral (white) wire to the center terminal block screw.

NOTE

The dryer is supplied with the neutral conductor grounded. If a 3-wire cord is to be used and is allowed, make sure the white neutral grounding wire is connected to the green ground screw.

- 6 Connect the external ground (if required by local codes) to the green ground screw.
- 7 Tighten all screws securely.
- 8 Reinstall the terminal block access cover.

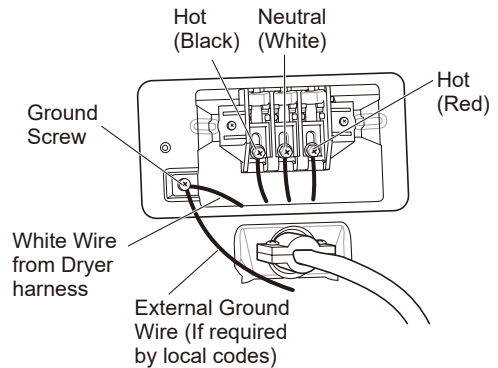

Three-Wire Direct Wire

- A 3-wire connection is NOT permitted on new construction after January 1, 1996.



- A UL-listed strain relief is required.
- Use UL-listed 3-wire, #10 AWG-minimum copper conductor cable. Allow at least 5 ft. (1.5 m) length to allow for removal and installation of dryer.

- 1 Remove 3½-inch (8.9 cm) of the outer covering from the wire. Strip 1 inch (2.5 cm) insulation from each wire. Bend the ends of the three wires into a hook shape.

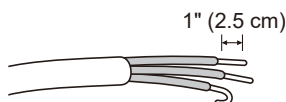

- 2 Remove the terminal block access cover on the upper back of the dryer.
- 3 Install a UL-listed strain relief into the power cord through-hole.
- 4 Thread the 3-wire, #10 AWG-minimum copper conductor power cable prepared in step 1 through the strain relief.

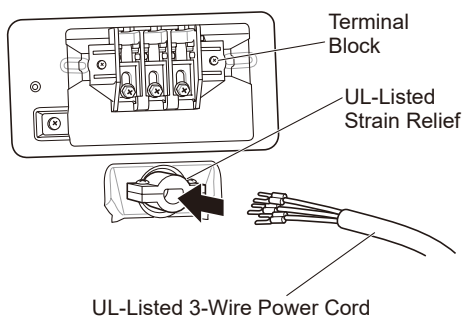

- 5 Attach the two hot leads (black and red) of the power cord to the outer terminal block screws.
- 6 Attach the neutral (white) wire to the center terminal block screw.

NOTE

The dryer is supplied with the neutral conductor grounded. If a 3-wire cord is to be used and is allowed, make sure the white neutral grounding wire is connected to the green ground screw.

- 7 Connect the external ground (if required by local codes) to the green ground screw.
- 8 Tighten all screws securely.

- 9 Reinstall the terminal block access cover.

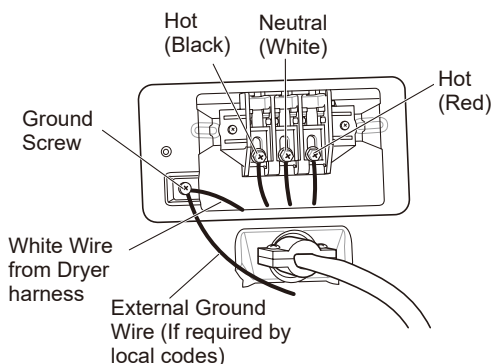

Final Installation Check

Once you have completed the installation of the dryer and it is in its final location, confirm proper operation with the following tests and the Installation Test (Duct Check) on the following page.

Testing Dryer Heating

GAS MODELS

Close the dryer door, press the **Encendido/Apagado (Power)** button to turn the dryer on, and start the dryer on a heat setting. When the dryer starts, the igniter should ignite the main burner.

ELECTRIC MODELS

Close the dryer door, press the **Encendido/Apagado (Power)** button to turn the dryer on, and start the dryer on a heat setting. The exhaust air should be warm after the dryer has been operating for 3 minutes.

Checking Airflow

Effective dryer operation requires proper airflow. The adequacy of the airflow can be measured by evaluating the static pressure. Static pressure in the exhaust duct can be measured with a manometer, placed on the exhaust duct approximately 2 ft. (60.9 cm) from the dryer. Static pressure in the exhaust duct should not exceed 0.6-inch (1.5 cm). The dryer should be checked while the dryer is running with no load.

Checking Levelness

Once the dryer is in its final location, recheck the dryer to be sure it is level. Make sure it is level front to back and side to side, and that all four leveling feet are firmly on the floor.

Checking Venting

Vent ductwork should be checked for lint buildup and cleaned at least once per year. If any noticeable reduction in drying performance occurs, check duct for obstructions and blockages.

Installation Test (Duct Check)

Once you have completed the installation of the dryer, use this test to make sure the condition of the exhaust system is adequate for proper operation of the dryer. This test should be performed to alert you to any serious problems in the exhaust system of your home.

- This dryer features Flow Sense™, an innovative sensing system that automatically detects blockages and restrictions in dryer ductwork. Keeping ductwork clean of lint buildup and free of restrictions allows clothes to dry faster and reduces energy use.

NOTE

The dryer should be cool before starting this test. If the dryer was warmed up during installation, run the Secado Con Aire (Air Dry) cycle for a few minutes to reduce the interior temperature.

To activate the installation test:

- 1 Remove the drying rack and literature, and then close the door.**

Do not load anything in the drum for this test, as in may affect the accuracy of the results.

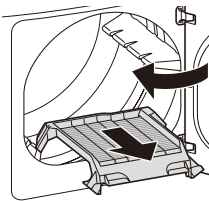

- 2 Press and hold the Anti Arrugas (Wrinkle Care) and Temp. buttons and then press the Encendido/Apagado (Power) button.**

(On models with a glass touch control panel, press the **Encendido/Apagado (Power)** button then IMMEDIATELY press and hold the **Temp.** and **Anti Arrugas (Wrinkle Care)** buttons.) This button sequence activates the installation test. The code **1n** will display if the activation is successful.



- 3 Press the Inicio/Pausa (Start/Pause) button.** The dryer will start the test, which will last about 2 minutes. The heat will be turned on and the temperatures in the drum will be measured and displayed. A chime sounds when the test portion of the cycle is complete.



- 4 Check the display for results.** During the test cycle, monitor the Flow Sense™ display on the control panel. If the Flow Sense™ LED has not turned on, when the cycle ends, the exhaust system is adequate. If the exhaust system is severely restricted, the Flow Sense™ LED will turn on. Other problems may also be shown with error codes. See the chart on the next page for error code details and solutions.

Sensor de Flujo

LED turned on:
RESTRICTED

The Flow Sense™ LED indicates that the exhaust system is severely restricted. Have the system checked immediately, as performance will be poor.

- 5 End of cycle.** At the end of the test cycle, **00** will display. The test cycle will end and the dryer will shut off automatically after a short delay.



- **Check the error code before you call for service**

Error Code	Possible Causes	Solutions
tE1 or tE2	<ul style="list-style-type: none"> • Temperature sensor failure. 	<ul style="list-style-type: none"> • Turn off the dryer and call for service.
HS	<ul style="list-style-type: none"> • Humidity sensor failure. 	<ul style="list-style-type: none"> • Turn off the dryer and call for service.
PS or PF or nP	<ul style="list-style-type: none"> • Electric dryer power cord is not connected correctly, or house power supply is incorrect. • House fuse is blown, circuit breaker has tripped, or power outage has occurred. 	<ul style="list-style-type: none"> • Check the power supply or the connection of the power cord to the terminal block. Refer to the Connecting Electric Dryers section of this manual for complete instructions. • Reset circuit breaker or replace fuse. Do not increase the fuse capacity. If the problem is a circuit overload, have it corrected by a qualified electrician.
gAS	<ul style="list-style-type: none"> • Gas supply or service turned off. (Gas Model only.) 	<ul style="list-style-type: none"> • Confirm that house gas shutoff and the dryer gas shutoff are both fully open.

- **Check the duct condition**

If the Flow Sense™ LED is turned on, check the exhaust system for restrictions and damage. Repair or replace the exhaust system as needed.

NOTE

When the dryer is first installed, this test should be performed to alert you to any existing problems with the exhaust duct in your home. However, since the test performed during normal operation provides more accurate information on the condition of the exhaust duct than does the installation test, the number of bars displayed during the two tests may not be the same.

Do not interrupt the test cycle, as this could result in inaccurate results.

Even if no bars are displayed during the test cycle, some restrictions may still be present in the exhaust system. Refer to the **Venting the Dryer** section of this manual for complete exhaust system and venting requirements.

Your dryer features Flow Sense™, an innovative sensing system that automatically detects blockages and restrictions in the dryer ductwork. Keeping ductwork clean of lint buildup and free of restrictions allows clothes to dry faster and reduces energy use.

Restricted or Blocked Airflow

Avoid long runs or runs with multiple elbows or bends.

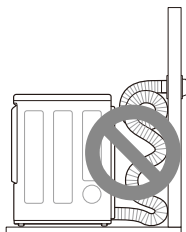

Excess or crushed transition duct

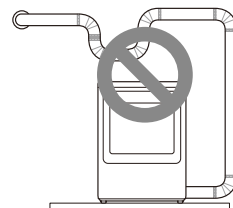

Too many elbows or exhaust too long

Check for blockages and lint buildup.

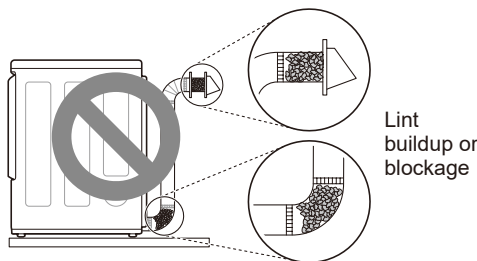

Lint buildup or blockage

Make sure the ductwork is not crushed or restricted.

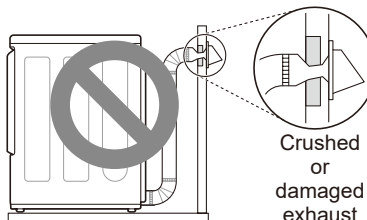

Crushed or damaged exhaust

OPERATION

⚠ WARNING

To reduce the risk of fire, electric shock, or injury to persons, read this entire manual, including the **IMPORTANT SAFETY INSTRUCTIONS**, before operating this dryer.

Using the Dryer

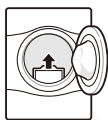

1 Clean the Lint Filter

If the lint filter has not already been cleaned, lift out the filter and remove the lint from the last load. This will help ensure the fastest and most efficient drying performance. Make sure to reinstall the filter, pressing down until it clicks firmly into place. The dryer will not operate without the lint filter in place.

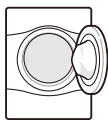

2 Load the Dryer

Load the dryer with the wet laundry from the washer. If the load is extra large, you may need to divide it into smaller loads for proper performance and fabric care.



3 Turn on The Dryer

Press the Encendido/Apagado (Power) button to turn on the dryer. The cycle LEDs will illuminate and a chime will sound.



4 Select a Cycle

Turn the cycle selector knob in either direction until the LED for the desired cycle is on. The preset temperature, dry level, and option settings for that cycle will be shown. Default settings for the selected cycle can now be changed if desired. Refer to the Cycle Setting and Options page for details.

NOTE

Not all options or modifiers are available on all cycles. A different chime will sound and the LED will not come on if the selection is not allowed.



5 Begin the Cycle

Press the **Inicio/Pausa(Start/Pause)** button to begin the cycle. The cycle can be paused at any time either by opening the door or by pressing the **Inicio/Pausa(Start/Pause)** button. If the cycle is not restarted within 60 minutes of being paused, the dryer will shut off and the settings will be lost.



6 End of Cycle

When the cycle is finished, the chime will sound. Immediately remove your clothing from the dryer to reduce wrinkling. If Anti Arrugas(Wrinkle Care) is selected, the dryer will tumble briefly every few minutes to help prevent wrinkles from setting in the clothes.

Check the Lint Filter Before Every Load

Always make sure the lint filter is clean before starting a new load; a clogged lint filter will increase drying time. To clean, pull the lint filter straight up and roll any lint off the filter with your fingers. Do not rinse or wash the filter to remove lint. Push the lint filter firmly back into place. See **Regular Cleaning** for more information.

Always ensure the lint filter is properly installed before running the dryer. Running the dryer with a loose or missing lint filter will damage the dryer and articles in the dryer.

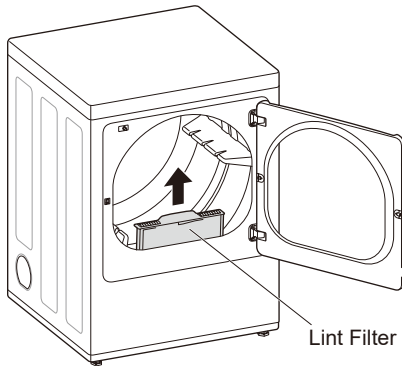

Sorting Loads

Fabric Care Labels

Most articles of clothing feature fabric care labels that include instructions for proper care.

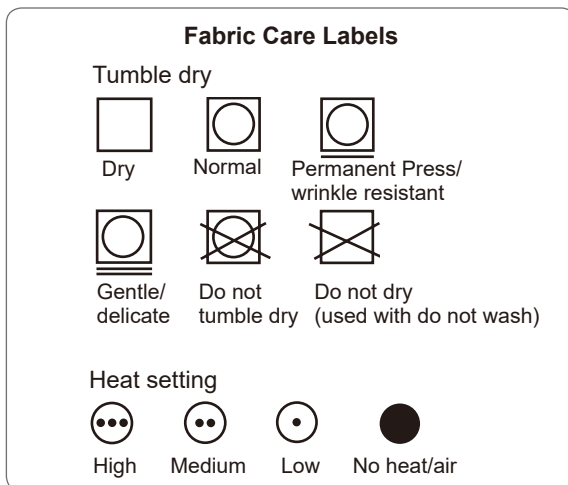

Group Similar Items

For best results, sort clothes into loads that can be dried with the same drying cycle.

Different fabrics have different care requirements, and some fabrics will dry more quickly than others. For best fabric care results, always dry fabrics with similar care requirements together.

Loading the Dryer

WARNING

To reduce the risk of fire, electric shock, or injury to persons when using this appliance, follow basic precautions, including the following:

- Check all pockets to make sure that they are empty. Items such as clips, pens, coins, and keys can damage both your dryer and your clothes. Flammable objects such as lighters or matches could ignite, causing a fire. Failure to do so may result in fire, explosion, or death.
- Never dry clothes that have been exposed to oil, gasoline, or other flammable substances. Washing clothes will not completely remove oil residues. Failure to obey this warning may result in fire, explosion, or death.

NOTE

Loading Tips

- Combine large and small items in the same load.
- Damp clothes will expand as they dry. Do not overload the dryer; clothes require room to tumble and dry properly.
- Use mesh laundry bags to separate clothes with zippers, hooks, straps, and drawstrings to prevent them from catching on or tangling with other clothes or damaging the lint filter.

Control Panel

Non-Steam Models (DF20*V2W / DF20VV2WE / DF50*V2S6W / DF50*V2S6WE)

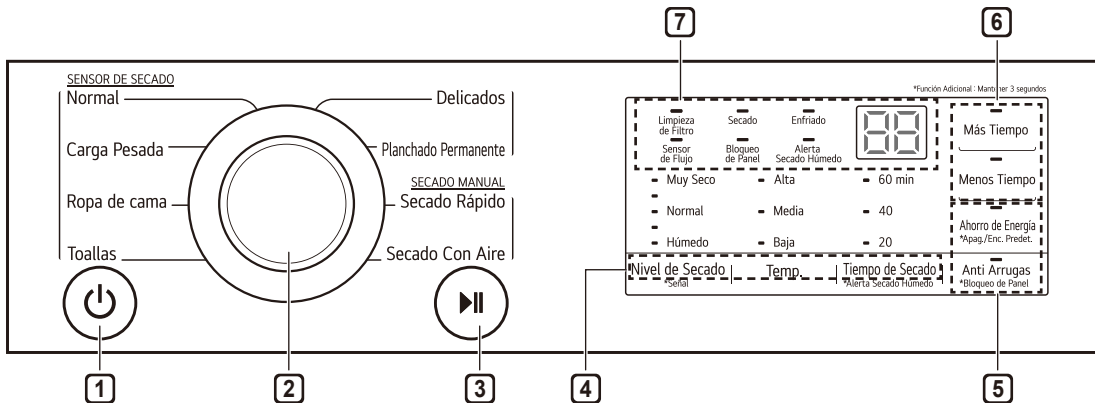

1 Encendido/Apagado (Power) Button

Press to turn the dryer Encendido(On). Press again to turn the dryer Apagado(off).

NOTE

Pressing the **Encendido/Apagado (Power)** button during a cycle will cancel that cycle and any load settings will be lost.

2 Cycle Selector Knob

Turn this knob to select the desired cycle. Once the desired cycle has been selected, the standard presets are shown in the display. On Secado Manual (Manual Dry) cycles, these settings can be adjusted using the cycle modifier buttons any time before starting the cycle.

3 Inicio/Pausa(Start/Pause) Button

Press this button to start the selected cycle. If the dryer is running, use this button to pause the cycle without losing the current settings.

NOTE

If you do not press the **Inicio/Pausa(Start/Pause)** button to resume a cycle within 60 minutes, the dryer turns off automatically.

4 Cycle Modifier Buttons

Use these buttons to select the desired cycle settings for the selected cycle. The current settings are shown in the display. Press the button for that modifier to select other settings.

5 Cycle Option Buttons

The option buttons allow you to select additional cycle options. Certain buttons also allow you to activate special functions by pressing and holding the button for 3 seconds.

6 Más Tiempo/Menos Tiempo (More Time/Less Time) Buttons

Use these buttons with the Tiempo de Secado (Time Dry) and other Secado Manual (Manual Dry) cycles to adjust the drying time. Press the **Más Tiempo (More Time)** button to increase the selected manual cycle time by 1 minute; press the **Menos Tiempo (Less Time)** button to decrease the cycle time by 1 minute.

7 Time and Status Display

The display shows the settings, estimated time remaining, options, and status messages for the dryer.

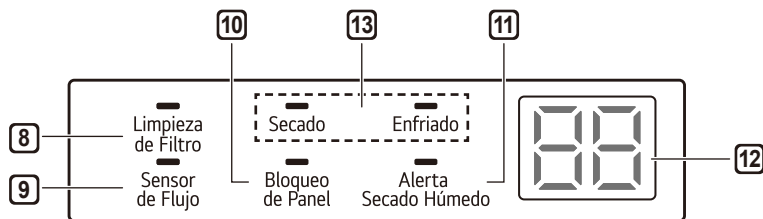

8 Clean Filter Reminder

The display will show Clean Filter when the dryer is turned on as a reminder to check the filter. It turns off when the **Inicio/Pausa(Start/Pause)** button is pressed.

9 Flow Sense™ Duct Blockage Sensing System Indicator

The Flow Sense™ duct blockage sensing system detects and alerts you to blockages in the ductwork that reduce exhaust flow from the dryer. Maintaining a clean exhaust system improves operating efficiency and helps minimize service calls, saving you money.

10 Bloqueo de panel (Control Lock) Indicator

When **Bloqueo de panel (Control Lock)** is set, the **Bloqueo de panel (Control Lock)** indicator appears and all buttons are disabled except the **Encendido/ Apagado (Power)** button. This prevents children from changing settings while the dryer is operating.

11 Damp Dry Signal Indicator

The dryer will signal when the load is approximately 80% dry. This allows you to remove faster-drying lightweight items or items that you would like to iron or hang while still slightly damp.

12 Estimated Time Remaining

This display shows the estimated time remaining for Sensor de Secado (Sensor Dry) cycles or the actual time remaining for Tiempo de Secado (Time Dry) or Secado Manual (Manual Dry) cycles.

NOTE

The cycle time on Sensor de Secado (Sensor Dry) cycles may fluctuate as the dryer recalculates drying time for optimal results.

13 Cycle Completion Indicator with Check Filter Reminder

This portion of the display shows which stage of the drying cycle is currently underway (Secado(Dry), Enfriado(Cool)).

Cycle Guide

Sensor de Secado (Sensor Dry) cycles

Sensor de Secado (Sensor Dry) cycles utilize LG's unique dual sensor system to detect and compare the moisture level in clothes and in the air and adjust the drying time as needed to ensure superior results. The dryer automatically sets the dryness level and temperature at the recommended setting for each cycle. The estimated time remaining will be shown in the display.

NOTE

To protect your garments not every dryness level, temperature, or option is available with every cycle. See the **Cycle Guide** for details.

Secado Manual (Manual Dry) cycles

Use Secado Manual (Manual Dry) cycles to select a specific amount of drying time and a drying temperature. When a Secado Manual (Manual Dry) cycle is selected, the Estimated Time Remaining display shows the actual time remaining in your cycle. You can change the actual time in the cycle by pressing **Más Tiempo (More Time)** or **Menos Tiempo (Less Time)**.

NOTE

- The **Ahorro de Energía(Energy Saver)** option is turned on by default in the Normal Cycle. Turn off the **Ahorro de Energía(Energy Saver)** option for a faster Normal cycle which begins with heated drying. To turn the **Ahorro de Energía(Energy Saver)** default off, press and hold the **Ahorro de Energía(Energy Saver)** button. **Encendido(On)** or **Apagado(off)** appears in the display.

Non-Steam Models (DF20*V2W / DF20VV2WE / DF50*V2S6W / DF50*V2S6WE)

- = default setting
- = allowable option
- * = Ahorro de Energia(Energy Saver)
on by default

Cycle	Fabric Type	Nivel de Secado (Dry Level)	Temp.	Anti Arrugas (Wrinkle Care)	Alerta Secado Húmedo (Damp Dry Signal)
SENSOR DE SECADO(SENSOR DRY)					
Normal*	Work clothes, corduroys, etc.	Normal	Media (Medium)	●	●
		Adj.			
Carga Pesada (Heavy Duty)	Jeans, heavyweight items	Normal	Alta (High)	●	●
		Adj.			
Ropa de cama (Bedding)	Comforters, Pillows, Shirts	Normal	Media (Medium)		
		Adj.			
Toallas (Towels)	Denims, towels, heavy cottons	Normal	Media (Medium)	●	●
		Adj.			
Planchado Permanente (Perm. Press)	Permanent press, synthetic items	Normal	Media (Medium)	●	●
		Adj.			
Delicados (Delicates)	Lingerie, sheets, blouses	Normal	Baja (Low)	●	●
		Adj.			
SECADO MANUAL(MANUAL DRY)					
Secado Rápido (Speed Dry)	For small loads with short drying times	Off	Alta (High)	●	
			Adj.		
Secado Con Aire (Air Dry)	For items that require heat-free drying such as plastics or rubber	Off	No Heat	●	

Cycle Settings and Options

Cycle Modifier Buttons

Sensor de Secado (Sensor Dry) cycles have preset settings that are selected automatically. Secado Manual (Manual Dry) cycles have default settings, but you may also customize the settings using the cycle modifier buttons. Press the button for that option to view and select other settings.

Nivel de Secado (Dry Level)

Selects the level of dryness for the cycle. Press the **Nivel de Secado (Dry Level)** button repeatedly to scroll through available settings.

- This option is only available with Sensor de Secado (Sensor Dry) cycles.
- The dryer will automatically adjust the cycle time. Selecting Seco(More) or Muy Seco(Very) will increase the cycle time, while Menos Seco(Less) or Húmedo(Damp) will decrease the cycle time.
- Use a Menos Seco(Less) or Húmedo(Damp) setting for items that you wish to iron.

Temp.

Adjusts the temperature setting. This allows precise care of your fabrics and garments. Press the **Temp.** button repeatedly to scroll through available settings.

Tiempo de Secado (Time Dry)

Allows you to manually select the drying time, from 20 to 60 minutes, in 20-minute increments. Use this for small loads or to remove wrinkles.

Más Tiempo/Menos Tiempo (More Time/Less Time)

Use the **Más Tiempo/Menos Tiempo (More Time/Less Time)** buttons to add or reduce the drying time of a Secado Manual (Manual Dry) cycle in 1-minute increments.

Cycle Option Buttons

The dryer features several additional cycle options to customize cycles to meet individual needs. Certain option buttons also feature a special function that can be activated by pressing and holding that option button for 3 seconds. (See Special Functions on the following page for details.)

Adding Cycle Options to a Cycle:

- 1 Turn on the dryer and turn the cycle selector knob to select the desired cycle.
- 2 Use the cycle modifier buttons to adjust the settings for that cycle.
- 3 Press the cycle option button(s) for the option you would like to add. A confirmation message is shown in the display.
- 4 Press the **Inicio/Pausa(Start/Pause)** button to start the cycle. The dryer starts automatically.

Anti Arrugas(Wrinkle Care)

Selecting this option will tumble the load periodically for up to 3 hours after the selected cycle, or until the door is opened. This is helpful in preventing wrinkles when you are unable to remove items from the dryer immediately.

Ahorro de Energía(Energy Saver)

This option helps to reduce the energy consumption of the Normal Cycle, depending on the load size. When the **Ahorro de Energía(Energy Saver)** option is selected, the cycle begins with an air dry section and the drying time is increased.

Special Functions

Some cycle option buttons also activate secondary functions. These special functions are marked with an asterisk (*). Press and hold the option button marked with the special function to activate it.

* Bloqueo de Panel(Control Lock)

Use this option to prevent unwanted use of the dryer or to keep cycle settings from being changed while the dryer is operating.

Press and hold the button marked Anti Arrugas(Wrinkle Care) for 3 seconds to activate or deactivate the Bloqueo de Panel(Control Lock) function. The Bloqueo de Panel(Control Lock) icon will be shown in the display, and all controls will be disabled except the **Encendido/Apagado (Power)** button.

NOTE

Once set, Bloqueo de Panel(Control Lock) remains active until it is manually deactivated. Bloqueo de Panel(Control Lock) must be turned off to run another cycle. To deactivate Bloqueo de Panel(Control Lock), press and hold the Anti Arrugas(Wrinkle Care) button for 3 seconds.

Alerta Secado Húmedo(Damp Dry Signal)

With this option, the dryer will signal when the load is approximately 80% dry. This allows you to remove faster-drying lightweight items or items that you would like to iron or hang while still slightly damp.

Señal(Signal)

Press and hold the Nivel de Secado (Dry Level) button for 3 seconds to adjust the volume of the signal. Press and hold the button repeatedly to adjust the volume of the melody. When no signal is heard, the signal is off. The volume settings are ON – OFF. The signal volume can be adjusted at any time as long as the dryer is turned ON.

* Apag./Enc. Predet.(Default On/Off)

This option allows the **Ahorro de Energía(Energy Saver)** settings to be changed. To run a Normal cycle without the **Ahorro de Energía(Energy Saver)** option, press and hold the **Ahorro de Energía(Energy Saver)** button for three seconds. Encendido(On) or Apagado(Off) appears in the display.

SMART FUNCTIONS

LG ThinQ Application



Installing the LG ThinQ Application

Search for the LG ThinQ application from the Google Play Store or Apple App Store on a smartphone. Follow instructions to download and install the application.

LG ThinQ Application Features

- **Smart Diagnosis™**
 - This function provides useful information for diagnosing and solving issues with the appliance based on the pattern of use.

Smart Diagnosis™ Feature

This feature is only available on models with the  or  logo. Use this feature to help you diagnose and solve problems with your appliance.



NOTE

- For reasons not attributable to LGE's negligence, the service may not operate due to external factors such as, but not limited to, Wi-Fi unavailability, Wi-Fi disconnection, local app store policy, or app unavailability.
- The feature may be subject to change without prior notice and may have a different form depending on where you are located.

Using Audible Diagnosis to Diagnose Issues

Follow the instructions below to use the audible diagnosis method.

- Launch the **LG ThinQ** application and select the **Smart Diagnosis** feature in the menu. Follow the instructions for audible diagnosis provided in the **LG ThinQ** application.

- 1 Press the Power button to turn on the appliance.
 - Do not press any other buttons.
- 2 Hold the mouthpiece of your phone in front of the  or  logo.

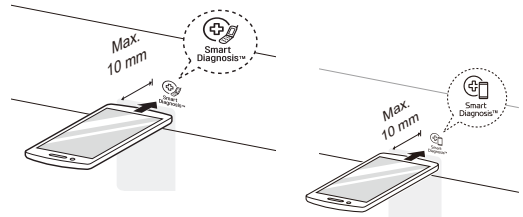

- 3 Press and hold the **Temp.** button for 3 seconds or longer while continuing to hold your phone to the logo.
- 4 Keep the phone in place until the tone transmission has finished. The display will count down the time. Once the countdown is over and the tones have stopped, the diagnosis will be displayed in the application.

NOTE

- For best results, do not move the phone while the tones are being transmitted.

MAINTENANCE

Regular Cleaning

⚠ WARNING

To reduce the risk of fire, electric shock, or injury to persons when using this appliance, follow basic precautions, including the following:

- **Unplug the dryer before cleaning to avoid the risk of electric shock.** Failure to follow this warning may cause **serious injury, fire, electric shock, or death.**
- **Never use harsh chemicals, abrasive cleaners, or solvents to clean the washer.** They will damage the finish.

Cleaning the Exterior

Proper care of your dryer can extend its life. The outside of the machine can be cleaned with warm water and a mild, nonabrasive household detergent. Immediately wipe off any spills with a soft, damp cloth.

NOTE

- Do not use methylated spirits, solvents, or similar products.
- Never use steel wool or abrasive cleansers; they can damage the surface.

Cleaning the Interior

Wipe around the door opening and seal with a soft, damp cloth to prevent lint and dust buildup that could damage the door seal.

Clean the window with a soft cloth dampened with warm water and a mild, nonabrasive household detergent, then wipe dry.

The stainless steel drum can be cleaned with a conventional stainless steel cleaner, used according to the manufacturer's specifications. Never use steel wool or abrasive cleansers; they may scratch or damage the surface.

Cleaning Around and Under the Dryer

Vacuum lint and dust from around the dryer and underneath it regularly. Vent ductwork should be checked for lint buildup and cleaned at least once per year. If any noticeable reduction in airflow or drying performance occurs, immediately check ductwork for obstructions and blockages.

Maintaining Ductwork

Vent ductwork should be checked for lint buildup once per month and cleaned at least once per year. If any noticeable reduction in airflow or drying performance occurs, immediately check ductwork for obstructions and blockages. Contact a qualified technician or service provider.

Cleaning the Lint Filter

Always clean the lint from the filter after every cycle.

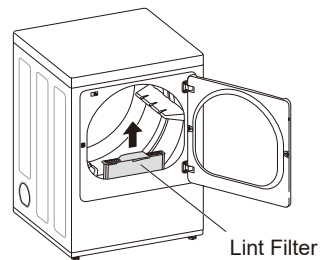

To clean, open the dryer door and pull the lint filter straight up. Then:

- 1 For everyday cleaning, roll any lint off the filter with your fingers, or

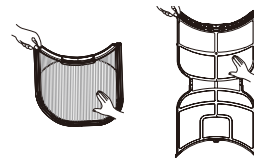

- 2 Vacuum the lint filter.

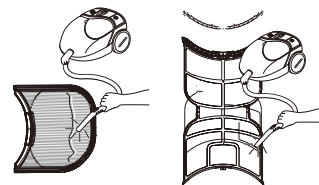

- 3 If the lint filter has become very dirty or clogged with fabric softener, wash the lint filter in warm, soapy water and allow it to dry thoroughly before reinstalling.

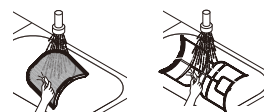

NOTE

NEVER operate the dryer without the lint filter in place. **NEVER** operate the dryer with a wet lint filter.

TROUBLESHOOTING

FAQs: Frequently Asked Questions

Q: When I press a button, why does my dryer beep and then nothing happens?

A: The Bloqueo de Panel(Control Lock) feature is turned on. To turn off Bloqueo de Panel(Control Lock), turn the dryer on, then press and hold the button that has *Bloqueo de Panel(Control Lock) on or under it for 3 seconds.

Q: Why does my dryer take so long to dry clothes?

A: Proper airflow is critical to the efficient operation of clothes dryers. A lint filter which is full of lint or clogged with fabric softener sheet residue can reduce the airflow to the point that the time required to dry clothing will be greatly increased. Another factor affecting dry time is your home exhaust system. An exhaust system which is dirty and clogged with lint, or is excessively long, needs to be professionally cleaned or repaired.

Q: Why does my dryer start by itself every few minutes?

A: This is how the Anti Arrugas(Wrinkle Care) feature works. The dryer runs briefly every few minutes for up to 3 hours after the cycle finishes. This feature is designed to help prevent wrinkles from setting in when the dryer is not unloaded immediately after the cycle is finished.

Before Calling for Service

This dryer is equipped with an automatic error-monitoring system to detect and diagnose problems at an early stage. If the dryer does not function properly or does not function at all, check the following before you call for service.

Operation

Problem	Possible Cause	Solutions
The Flow Sense™ indicator remains active after clearing the restriction in the venting.	After clearing the restriction, the Flow Sense™ system requires multiple, consecutive cycles to determine that the performance value has improved before the Flow Sense™ indicator is reset.	If the Flow Sense™ indicator remains active for more than five cycles after the restriction has been cleared, call for service.
Dryer will not turn on	Power cord is not properly plugged in. House fuse is blown, circuit breaker has tripped, or power outage has occurred.	Make sure that the plug is securely plugged into a grounded outlet matching the dryer's rating plate. Reset circuit breaker or replace fuse. Do not increase fuse capacity. If the problem is a circuit overload, have it corrected by a qualified electrician.
Dryer does not heat	House fuse is blown, circuit breaker has tripped, or power outage has occurred. Gas supply or service is turned off (gas models only). Ahorro de Energía(Energy Saver) option selected (on some models)	Reset circuit breaker or replace fuse. Do not increase fuse capacity. If the problem is a circuit overload, have it corrected by a qualified electrician. NOTE Due to the design of electric dryers, it is possible for a circuit problem to allow an electric dryer to run without heat. Confirm that the house gas shutoff and the dryer gas shutoff valves are both fully open. Even if gas is not supplied to the dryer, it will run and display error code. Verify that other gas appliances in the home are working normally. If using the Normal cycle, deselect the Ahorro de Energía(Energy Saver) option. The Ahorro de Energía(Energy Saver) option is selected by default. This option reduces energy use by adding an air dry section to the beginning of the cycle. It is normal to feel no heat at the beginning of the cycle while in Ahorro de Energía(Energy Saver) mode.
Display show error code nP	Electric dryer power cord is not connected correctly, or house power supply is incorrect.	Check the power supply or the connection of the power cord to the terminal block.
Display show error code gAS	Gas supply or service turned off (gas models only).	Confirm that house gas shutoff and the dryer gas shutoff are both fully open.

Problem	Possible Cause	Solutions
Clothes take too long to dry	Exhaust ducts are blocked, dirty, or duct run is too long.	Confirm that the exhaust duct is properly configured and free of debris, lint, and obstructions. Make sure that outside wall dampers can open properly and are not blocked, jammed, or damaged.
	Load is not properly sorted.	Separate heavy items from lightweight items. Larger and heavier items take longer to dry. Light items in a load with heavy items can fool the sensor because the light items dry faster.
Clothes take too long to dry	Large load of heavy fabrics.	Heavy fabrics take longer to dry because they tend to retain more moisture. To help reduce and maintain more consistent drying times for large and heavy fabrics, separate these items into smaller loads of a consistent size.
	Dryer controls are not set properly.	Use the appropriate control settings for the type of load you are drying. Some loads may require an adjustment of the dry level setting for proper drying.
	Lint filter needs to be cleaned.	Remove the lint from the filter before every load. With the lint removed, hold the filter up to a light to see if it is dirty or clogged. With some loads that produce high amounts of lint, such as new bath towels, it may be necessary to pause the cycle and clean the filter during the cycle.
	House fuse is blown, circuit breaker has tripped, or power outage has occurred.	Reset circuit breaker or replace fuse. Do not increase fuse capacity. If the problem is a circuit overload, have it corrected by a qualified electrician. <div data-bbox="820 1205 1263 1367" style="border: 1px solid black; padding: 5px; margin-top: 10px;"> <p>NOTE</p> <p>Due to the design of electric dryers, it is possible for a circuit problem to allow an electric dryer to run without heat.</p> </div>
	Dryer is overloaded.	Divide extra large loads into smaller loads for better drying performance and efficiency.
	Dryer is underloaded.	If you are drying a very small load, add a few extra items to ensure proper tumbling action. If the load is very small and you are using Sensor de Secado (Sensor Dry) cycles, the electronic control cannot properly sense the dryness of the load and may shut off too soon. Use Tiempo de Secado (Time Dry) or add some extra wet clothes to the load.

Problem	Possible Cause	Solutions
Clothes take too long to dry	Ahorro de Energía(Energy Saver) option selected (on some models)	If using the Normal cycle, deselect the Ahorro de Energía(Energy Saver) option. This option reduces energy use by adding an air dry section to the beginning of the cycle.
Drying time is not consistent	Heat settings, load size, or dampness of clothing is not consistent.	The drying time for a load will vary depending on the type of heat used (electric, natural gas, or LP gas), the size of the load, the type of fabrics, the wetness of the clothes, and the condition of the exhaust duct and lint filter. Even an unbalanced load in the washer can cause poor spinning, resulting in wetter clothes which will take longer to dry.

Performance

Problem	Possible Cause	Solutions
Greasy or dirty spots on clothes	Fabric softener used incorrectly.	Confirm and follow the instructions provided with your fabric softener.
	Clean and dirty clothes are being dried together.	Use your dryer to dry only clean items. Soil from dirty clothes can transfer to the clean clothes in the same or later loads.
	Clothes were not properly cleaned or rinsed before being placed in the dryer.	Stains on dried clothes could be stains that were not removed during the washing process. Make sure that clothes are being completely cleaned or rinsed according to the instructions for your washer and detergent. Some difficult soils may require pre-treating prior to washing.
Clothes are wrinkled	Clothes dried too long (over dried).	Over drying a load of laundry can lead to wrinkled clothes. Try a shorter drying time or LESS DRY setting and remove items while they still retain a slight amount of moisture.
	Clothes left in dryer too long after cycle ends.	Use the Anti Arrugas(Wrinkle Care) option. This feature will tumble the clothes briefly every few minutes for up to 3 hours to help prevent wrinkling.
Clothes are shrinking	Garment care instructions are not being followed.	To avoid shrinking your clothes, always consult and follow fabric care instructions. Some fabrics will naturally shrink when washed. Other fabrics can be washed but will shrink when dried in a dryer. Use a low or no heat setting.
Lint on clothes	Lint filter not cleaned properly.	Remove the lint from the filter before every load. With the lint removed, hold the filter up to a light to see if it is dirty or clogged. If it looks dirty, follow the cleaning instructions. With some loads that produce high amounts of lint, it may be necessary to clean the filter during the cycle.
	Laundry not sorted properly.	Some fabrics are lint producers (i.e., a fuzzy white cotton towel) and should be dried separately from clothes that are lint trappers (i.e., a pair of black linen pants).
	Excess static in clothes.	Use a fabric softener to reduce static electricity. Be sure to follow the manufacturer's instructions. Overdrying a load of laundry can cause a buildup of static electricity. Adjust settings and use a shorter drying time, or use Sensor de Secado (Sensor Dry) cycles.
	Dryer is overloaded.	Divide extra large loads into smaller loads for drying.
	Tissue, paper, etc., left in pockets.	Check pockets thoroughly before washing and drying clothes.

Problem	Possible Cause	Solutions
<p>Excess static in clothes after drying</p>	<p>Fabric softener is not used or used incorrectly.</p>	<p>Use a fabric softener or the Reducir Estática(Reduce Static) option, if equipped, to reduce static electricity. Be sure to follow the manufacturer's instructions.</p>
	<p>Clothes dried too long (overdried).</p>	<p>Overdrying a load of laundry can cause a buildup of static electricity. Adjust settings and use a shorter drying time, or use Secado Manual (Manual Dry) cycles. Select a LESS DRY setting on Sensor de Secado (Sensor Dry) cycles, if necessary.</p>
	<p>Drying synthetics, permanent press, or synthetic blends.</p>	<p>These fabrics are naturally more prone to static buildup. Try using fabric softener, or use LESS DRY and/or shorter Tiempo de Secado (Time Dry) time settings.</p>
<p>Clothes have damp spots after a Sensor de Secado (Sensor Dry) cycle.</p>	<p>Very large load or very small load. Single large item such as a blanket or comforter.</p>	<p>If items are too tightly packed or too sparse the sensor may have trouble reading the dryness level of the load. Use a Time Dry cycle for very small loads.</p> <p>Large, bulky items such as blankets or comforters can sometimes wrap themselves into a tight ball of fabric. The outside layers will dry and register on the sensors, while the inner core remains damp. When drying a single bulky item, it may help to pause the cycle once or twice and rearrange the item to unwrap and expose any damp areas.</p> <p>To dry a few remaining damp items from a very large load or a few damp spots on a large item after a sensor cycle has completed, empty the lint trap, then set a Tiempo de Secado (Time Dry) cycle to finish drying the item(s).</p>

Error Codes

Problem	Possible Cause	Solutions
Error code: tE1 through tE7	Temperature sensor failure.	Turn off the dryer and call for service.
Display shows error code: PS (electric dryers only)	Power cord is connected incorrectly.	Check the connection of the power cord to the terminal block.
<p>*Flow Sense™ indicator shows four bars during the drying cycle or the display shows "d80" after drying</p> <p>* This warning light is not a dryer failure and is not covered by the dryer warranty. Contact a duct cleaning service to set up an appointment to have your exhaust system cleaned and inspected.</p>	<p>Exhaust system is too long or has too many turns/restrictions.</p> <p>Partial blockage of the ductwork due to lint buildup or other foreign object.</p> <p>The appliance has detected a restriction in the external dryer venting.</p>	<p>Install a shorter or straighter duct run. See the Installation Instructions for details.</p> <p>Ductwork should be checked/cleaned immediately. Dryer can be used in this condition, but drying times will be longer and energy consumption will increase.</p> <p>If exhaust restrictions are sensed by the Flow Sense™ system, the indicator will remain on for 2 hours after the end of the cycle. Opening the door or pressing the POWER button will turn off the display.</p>
The Flow Sense™ indicator remains active after clearing the restriction in the venting.	After clearing the restriction, the Flow Sense™ system requires multiple, consecutive cycles to determine that the performance value has improved before the Flow Sense™ indicator is reset.	If the Flow Sense™ indicator remains active for more than five cycles after the restriction has been cleared, call for service.
<p>The display shows</p> 	<p>The duct work is about 75% - 95% blocked. ("d75", "d80", "d90" or "d95" error code is displayed for 2 hours only)</p> <p>House exhaust system blocked.</p>	<p>Do not use the dryer until the exhaust system has been cleaned and/or repaired. Using the dryer with a severely restricted exhaust is dangerous and could result in a fire or other property damage. Check the outside dryer vent while the dryer is operating to make sure there is strong airflow.</p> <p>If the exhaust system is extremely long, have it repaired or rerouted.</p> <p>Keep the area around the dryer clean and free of clutter. Check vent hood for damage or lint clogging. Make sure the area around the vent hood is clear.</p>
Check filter indicator is on during the drying cycle	Lint filter not cleaned properly.	Remove the lint from the filter before every load. With the lint removed, hold the filter up to a light to see if it is dirty or clogged. If it looks dirty, follow the cleaning instructions. With some loads that produce high amounts of lint, it may be necessary to clean the filter during the cycle.

Memo