

2 YEARS WARRANTY



DRIJA

Livorno 76

PROFESSIONALE

Estufa Gas para Empotrar
Gas Stove Built-In

OBSEQUIO
1 Porta Wok



Estufa Gas para Empotrar
Gas Stove Built-In



TUTORIALS OF
TECHNICAL SUPPORT

USER MANUAL

110-220V / 50-60Hz

NOTA: Para adquirir accesorios y/o repuestos de este producto, contáctenos al call center (según el número de su país que le indique el certificado de garantía) o a nuestras redes sociales

NOTE: To purchase accessories and / or spare parts for this product, contact us at the call center (depending on the number of your country that indicates the warranty certificate) or our social networks

www.DrijaInternational.com

! Para conservar la garantía de este producto, es recomendable usar mangueras de acero

Para la Conexión a Gas

To preserve the warranty of this product, it is advisable to use steel hoses

For Gas Connection

User Manual
BUILT-IN GAS STOVE | LIVORNO 76



1. INTRODUCTION	2
2. SECURITY WARNING	3
3. HOW TO USE YOUR STOVE	5
4. HOW TO TAKE CARE OF YOUR GAS STOVE.....	6
5. INSTALLATION	9
6. SPECIFICATIONS TABLES	15

1. INTRODUCTION

Thank you for choosing our gas cook top.

To use this artifact correctly and prevent any potential risk, read these instructions before using it.

Keep these instructions in a place where you can find easily.

If you are not sure of any of the information contained in these instructions, please contact our customer service center.

The manufacturer shall not be responsible for any damages to persons or property caused by improper installation or misuse of your kitchen.

The artifact has been certified for use in countries other than those marked at the stove.

The manufacturer reserves the right to make any modifications to the products as may be considers necessary or useful, also in the interests of the user, without jeopardizing the main functional and safety features.

The artifact is designed for a domestic and non-commercial environment.

2. SECURITY WARNING

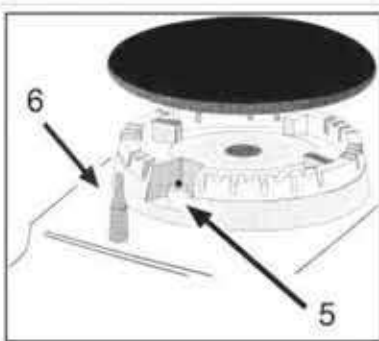

1. Auxiliary burner
2. Semi-rapid burner
3. Rapid burner
4. Triple ring wok burner
5. Ignitor for Gas Burners
6. Safety Device: Activates if the flame accidentally goes out (spills, drafts, etc.), interrupting the delivery of gas to the burner.
7. Control Knobs for Gas Burners and Electric Hot Plates



User Manual
BUILT-IN GAS STOVE | LIVORNO 76

DRIJA

MODELS	LIVORNO 76
Cooking Zone	5
Voltage	110/220V 50/60Hz
Total Power	11.6 kW
Front Side control operation	YES
Product Size D×W×H (mm)	760 x 500 x 100
Cut Out Dimensions D x W (mm)	730 x 480

Escala en cm
Medidas Internas

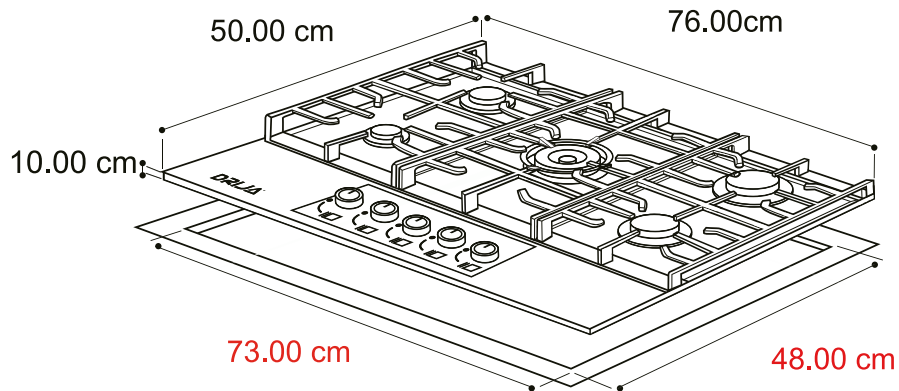

DRIJA

3. HOW TO USE YOUR STOVE

The position of the corresponding gas burner is indicated on each control knob.

Gas burners

The burners are different in size and power. Choose the most appropriate for the diameter of the kitchen utensils that are used.

The burner can be adjusted with the corresponding control knob using one of the following configurations



On those models equipped with a safety device

The knob must press and after being on wait 6 seconds, then release the knob to prevent it from turning off when you turn it on since your account has a safety valve.

To light a burner: simply press the corresponding knob and turn it counterclockwise to the High setting, press and hold until the burner ignites.

Caution: If the flame accidentally goes out, turn off the gas with the control knob and try to turn it on again at least 1 minute later.

To turn off a burner: Turn the knob clockwise until it stops (it must be in the "•" setting).

NOT ONE:

- *Make sure that after you clean the kitchen the lids and burners should be well placed if they are not properly not going or the flame will be very high if it ignites.*
- *The wock holder goes over the burners, its function is to help better cooking since the pan is cooked at 360 degrees and not only in the middle.*

4. HOW TO TAKE CARE OF YOUR GAS STOVE

Before cleaning or maintaining your gas plate, disconnect it from the power source (battery included).

- To extend the life of the gas plate, it is absolutely essential that it be thoroughly cleaned thoroughly and, in general, take into account the following:
- The removable parts of the burners should be washed generally with soap and warm water, be sure to remove the adhered substances;
- Automatic ignition pin, the end must be cleaned carefully and, in general, make sure that the ignition continues to function normally.
- The stainless steel top plate and other steel parts can get stained if they are kept in contact with high concentration limestone water or corrosive detergents (containing phosphorus). To extend the shelf life, we recommend you rinse these parts thoroughly with water and dry them by blowing. It is also a good idea to clean up any spillage.
- The stainless steel top plate and other steel parts can get stained if they are kept in contact with highly concentrated calcareous water or corrosive detergents (containing phosphorous). To extend the shelf life, we recommend that you rinse these parts well with water and blow dry. It is also a good idea to clean up any spills. (Use recommended cleaners for this type of material, we recommend the following; WD-40.)
-

First, to remove all food or grease residues with a cleaning scraper, Cleaning scraper (not supplied) (Fig. 1).

While the cooking surface is warm, clean it with a suitable cleaning product and paper towels, then wipe with a damp cloth and a dry surface. Like aluminum foil, plastic items, objects made of synthetic material, sugar or foods with a high sugar content that have melted on the surface, it must be removed immediately.

While the cooking surface is still hot, clean it with a scraper and a transparent protective film that prevents more dirt from accumulating. This also protects the surface from damage caused by foods with a high sugar content.

Do not use abrasive sponges or cleaning agents, this is valid for chemically aggressive cleaners, such as oven sprays and stain removers (Fig. 2);



When cleaning the grill / pan holder, it is recommended to clean it while it is still hot. To remove the grill from the plate and put it in the sink, remove any food or grease residue first, after the grill has cooled, rinse it with water.

For cleaning stainless steel it is recommended to use neutral soaps with warm water, then dry and apply a cloth with clean steel, mineral oil, moisturizing oils such as coconut oil, almond, etc; to brighten the stove.

Grease the gas valves

Over time, gas valves can get stuck and it is difficult to turn on / off. For this case, you must clean the inside of the valve and grease it.

Kind Reminder: This procedure must be performed by a technician authorized by the manufacturer.

Practical advice

Practical advice on the use of burners

For best performance, follow these general guidelines:

- Use the appropriate cooking utensils for each burner (see table) to prevent the flame from reaching the side of the pot or pan;
- Always use kitchen utensils with a flat bottom and keep the lid on;
- When the contents boil, turn the knob to "Low."

Burner	Ø Cookware diameter (cm)
Auxiliary burner	10~14
Semi-rapid burner	16~20
Rapid burner	22~24
Triple ring wok burner	24~26

Is there a problem?

If you find that the gas plate may not work suddenly or may not work properly. Before calling customer service for help, let's verify what we can do.

First, verify and confirm that there are no interruptions in gas and electricity supplies, particularly if the gas valves are kept open.

The burner cannot ignite or the flame is not uniform around the burner, check to make sure that:

- The gas holes in the burner are not clogged;
- All moving parts of the burners are fixed correctly;
- There is no air flow around the cooking surface.

The flame does not keep the burner burning with thermocouple, check to make sure that:

- Press the knob completely;
- Keep pressing the knob for long enough to activate the thermocouple.
- Gas holes are not obstructed in the area corresponding to the thermocouple.

The flame goes out when the knob is turned to the "Low" setting, check to make sure that:

- Gas holes are not clogged.
- There is no air flow around the cooking surface.
- The minimum has been set correctly (see the section entitled "Minimum regulation").

The kitchen battery is not stable, check to make sure that:

- The bottom of the kitchen utensils is perfectly flat.
- The kitchen battery is centered correctly on the burner.
- The support grilles have not been inverted.

After verifying all this, the gas plate still does not work properly, call the Customer Service Center and inform them about:

- Indicate what problem it presents.
- The model number of the gas stove as indicated on the packaging box.

Never call technicians who are not authorized by your supplier and refuse to use spare parts that are not from the manufacturer

5. INSTALLATION

The following instructions are addressed to the qualified installer, so installation and maintenance procedures can be followed in the most professional and expert manner.

Important: Unplug the electrical connection before performing any maintenance or regular maintenance.

Positioning for gas hob

Important: this unit can be installed and used only in rooms with permanent ventilation.

The following requirements must be met:

- a) The room must be equipped with a ventilation system that ventilates smoke and combustion gases outside the rooms. This should be done by hood or electric fan.



In a fireplace or fireproof
enclosure.
(exclusively for kitchen appliances)



Directly outside

- b) Air must be allowed for adequate combustion. The air flow for combustion purposes must not be less than $2 \text{ m}^3 / \text{h}$ per kW of installed capacity. The air supply will be effected by the inflow from the outside through a duct, its internal cross section is at least 100 cm^2 and should not be accidentally blocked.

The gas plate without safety devices, to prevent the flame from accidentally going out, must have ventilation that operates in two volumes. For example, a minimum of 200 cm^2 (Fig. 3). Otherwise, the room can be indirectly ventilated through adjacent rooms that are equipped with outside ventilation ducts. Although the adjacent rooms are not shared areas, the rooms, but the risk of fire is hidden (Fig. 4).

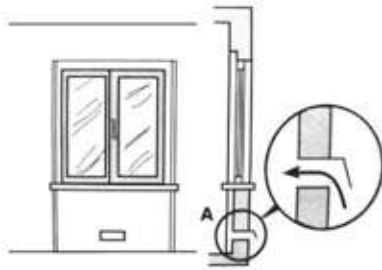

Examples of ventilation holes for combustion air.

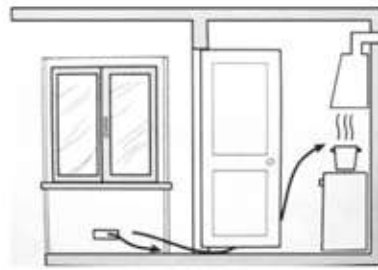

Enlarge the ventilation slot between the window and the floor

- c) Intensive and prolonged operation of the gas plate that needs to intensify ventilation, e.g. open windows or increase the power of the air intake system (if present).
- d) Liquefied petroleum gases are heavier than air, therefore, deposit them down. Rooms in which LPG tanks are installed must be equipped with outward ventilation to prevent gas leaks.

Therefore, LPG tanks that are empty or partially filled should not be installed or stored in rooms or spaces below ground level (warehouses, etc.). It is a good idea to keep only the tank currently operating in the room and make sure it is not closed to the heating source (ovens, fireplaces, stoves, etc.).

Installation of the built-in gas stove

The gas plates are designed with a degree of protection against excessive heating, the device can be installed next to the cabinets and the height must not exceed the plate.

For proper installation, the following precautions must be followed:

- a) The plate can be located in a kitchen, a dining room or in a bed / living room, but not in a bathroom or shower.
- b) The furniture standing near the unit, is taller than the work tables, must be placed at least 110 mm away from the edge of the table.
- c) The cabinets should be placed near the hood at a height of at least 420 mm (Fig. 5).

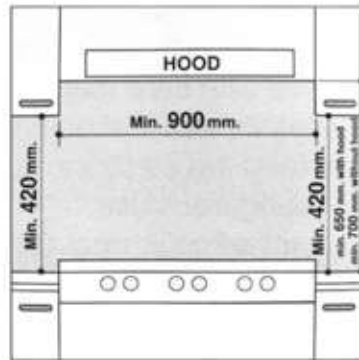

- d) The plate must be installed directly under a cabinet, the latter must be at least 700 mm from the worktop, as shown in Fig. C.
- e) Fixing accessories (hooks, screws) are provided to place the plate on the top of the table, measuring 20 to 40 mm thick (see Fig. 6).

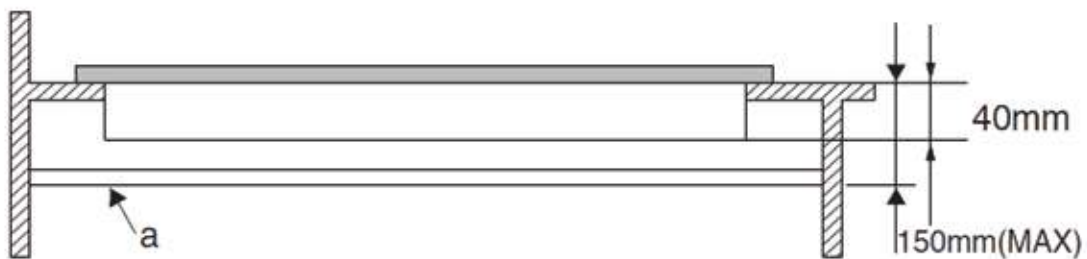
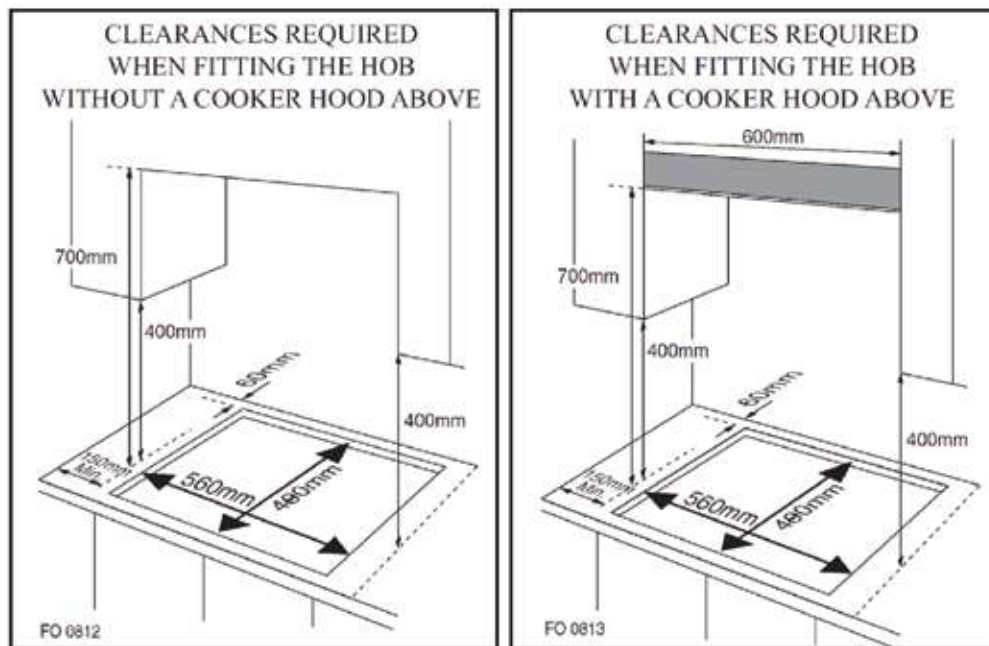

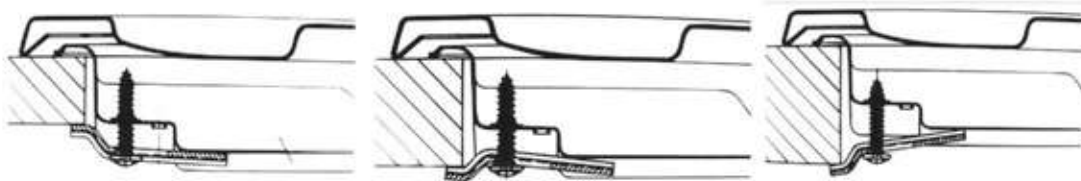

Hook position for

H=20mm top

Hook position for

H=30mm top

Hook position for

H=40mm top

- f) In the event that the gas plate is not installed in a built-in oven, a wooden panel must be inserted for insulation. This panel should be placed at least 20 mm away from the bottom of the plate.

Important: When installing the plate in a built-in oven, the oven must be placed in two strips of wood; In the case of a junction cabinet surface, remember to leave a space of at least 45 x 560 mm from the back.

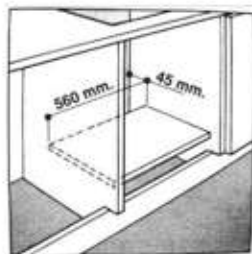
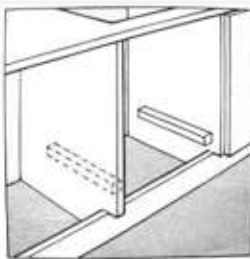

When installing a plate in a built-in oven without forced ventilation, be sure to have air inlets and outlets to properly ventilate the interior of the cabinet.

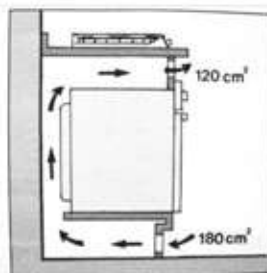
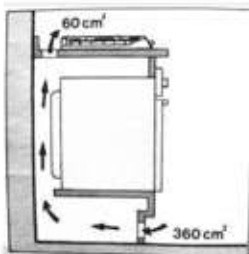

Gas connection for gas hob

The gas plate must be connected to the gas supply by a registered installer. During installation, it is essential to install an approved gas tap to isolate the supply of the plate for the convenience of any subsequent extraction or service. Connect the plate to the gas network or to the liquid gas, it must be carried out in accordance with the prescribed regulations in force, and only after checking that it is adaptable to the type of gas to be used. Otherwise, follow the

instructions in the paragraph entitled "Adaptation to different types of gas." In the case of the connection to the liquid gas per tank, use pressure regulators that comply with the current regulation.

Important: For safety, for the correct regulation of the use of gas and the long life of the plate, make sure that the gas pressure conforms to the indications given in table 1 "Burner and nozzle specifications".

Connection to non-flexible tube (copper or steel)

- The connection to the gas source must be made in such a way that it does not create any tension point in any part of the gas plate.
- The board is equipped with an adjustable "L" shaped connector and a gas supply gasket.
- The connector must be removed and the gasket must be replaced.
- The gas supply connector to the plate is threaded 1/2 gas cylinder.

Flexible steel tube connection.

The gas supply connector to the countertop is threaded, 1/2 "connector for round gas pipe. Use only pipes and sealing gaskets that meet current standards. The maximum length of flexible pipes must not exceed 2000 mm Once the connection has been made, make sure that the flexible metal tube does not touch any moving parts and does not crush.

Check the seal

Once the plate is installed, make sure all connections are properly sealed, use soapy water to test, never use flames.

Electric connection

The board is equipped with a three-pole power supply cable that is designed for use with alternating current. According to the indications on the nameplate located under the nameplate. The ground wire can be identified by its greenish yellow color.

In the case of installation on a built-in electric oven, the electrical connections for the plate and the oven must be independent, not only for a safe purpose, but also suitable for future disposal.

Electrical connection for gas hob

Adjust the power cable with a standard plug for the demand rate indicated on the nameplate or connect it directly to the mains. In the latter case, a one-pole switch must be placed between the board and the mains, with a minimum opening between the 3 mm contacts in accordance with current safety codes (the switch must not interrupt the connection cable to land). The power supply cable must be positioned so that it does not reach a temperature greater than 50 °C than the ambient temperature at any point.

Before the actual connection, make sure that:

- The fuse and the electrical system can withstand the load required by the board;
- The power supply system is equipped with an efficient ground connection in accordance with the rules and regulations prescribed by law;
- The plug or switch is easily accessible.

Important: the cables in the main cable are colored according to the following code:

Green and Yellow - Earth

Blue - Neutral

Brown - Live

Since the colors of the wires in the main wire may not correspond to the colored markings that identify the terminals on your plug, proceed as follows: Connect the green and yellow wire to the terminal marked "E" or green or green and yellow.

Connect the brown wire to the terminal marked "L" or red.

Connect the blue wire to the terminal marked "N" or black.

6. SPECIFICATIONS TABLES

Burner and nozzle specifications

Adapting the Gas hob for Different Types of Gas

Burner	G20		G30	
	Thermal power (kW)	Nozzle 1/100 (mm)	Thermal power (kW)	Nozzle 1/100 (mm)
Auxiliary (Small) (A)	1.0	71	1.0	52
Semi rapid (Medium)	1.80	97	1.8	67
Rapid (R)	3.0	115	3.0	84
Triple Ring (TR)	4.0	150	4.0	100
Supply pressures	20mbar		30mbar	

At 15°C and 1013 mbar - dry gas

P.C.I.G20 37.78 MJ/m³ P.C.I.G25.1 32.51 MJ/m³

P.C.I.G25 32.49 MJ/m³ P.C.I.G27 30.98 MJ/m³

P.C.I.G2.350 27.20MJ/ m³ P.C.I.G30 49.47MJ/Kg



Replacement of burner nozzle: loosen the nozzle with a dedicated wrench(7).Fit the new nozzle according to the required gas type (see table 1 for reference).

After you have converted the gas hob to another gas type, make sure you have placed a label containing that information on the appliance.

How to convert a gas source

Adjustment of the reduced valve flow

Burners	Flame	Converting the hob from LPG to natural gas	Converting the hob from natural gas Gas to LPG
Regular burners	Full flame	Replace the burner Nozzle according To the guidelines in table 1	Replace the burner Nozzle according to the guidelines in table 1
	Saving flame	Loosen the adjustment Spindle (see fig.7 below) And adjust the flame	Loosen the adjustment Spindle (see fig.7 below) And adjust the flame

Valve adjustment

Valve adjustment should be done with the control knob set at Burner ON saving flame position. Remove the knob, and adjust the flame with a tiny screwdriver (see fig.7 below).

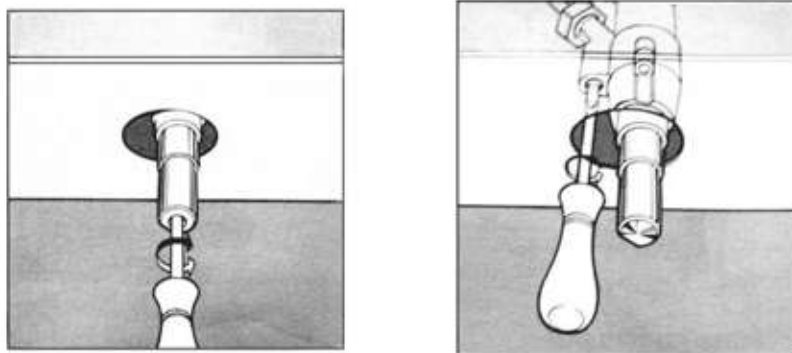
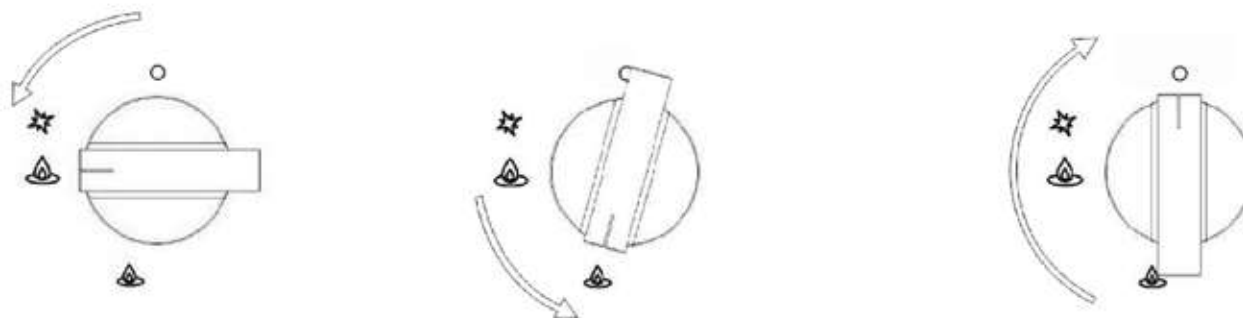

Fig.7

To check the adjusted flame: heat the burner at full open position for 10 minutes. Then turn the knob into the saving setting. The flame should not extinguish nor move to the nozzle. If it extinguish or moves to the nozzle, readjust the valves.

Flame selection

As the burners are adjusted correctly, the flame should be light blue, and the inner flame should be clear. The size of flame depends on the position of the related control knob.



-Burner ON, large flame

-Burner ON, small flame (saving mode)

-Burner OFF

Fig.8

See fig.8 for various operating options (flame size selection); the burner should be set at a large flame during the initial phase of cooking, it make food boil quickly. Then should turn knob to the saving flame position to maintain the cooking. It is possible to adjust the flame size stepless.

It is prohibited to adjust the flame between the Burner OFF and Burner ON large flame positions.

High quantity of energy can be conserved if the hob is used correctly, parameters are designed correctly, and appropriate cookware is used. The energy conservation be as follows:

- Up to 60% are conserved when proper pots are used,
- Up to 60% are conserved when the unit is operated correctly and the suitable flame size is chosen.

It is a prerequisite for efficient and energy-saving operation of hob that the burners are kept clean at all times (in particular the flame slots and nozzles). **Adapting to different types of gas**

Adaptation to different types of gas

APPLIANCE CATEGORY: I_{2H} I_{2E} I_{2E+} I_{2L} I_{2HS} I_{2ELS} I_{2ELW} I₃₊ I_{3B/P} I_{3B/P} I_{3B/P} I_{3P} I_{2H3+} II_{2E3B/P} II_{2HS3B/P} II_{2ELWLS3B/P} II_{2ELL3B/P}

Burner	Type of Gas	Pressure	Nozzle diameter	Nominal Charge				Reduced Charge	
		mbar	1/100mm	g/h	l/h	kW	kcal/h	kW	kcal/h
Auxiliary	Natural G20	20	71	—	95	1.0	860	0.40	344
	Butane G30	30	52	72.6	—	1.0	860	0.40	344
Semi-rapid	Natural G20	20	97	—	171	1.8	1548	0.60	516
	Butane G30	30	67	130.8	—	1.8	1548	0.60	516
Rapid	Natural G20	20	115	—	286	3.0	2580	0.90	774
	Butane G30	30	84	226	—	3.0	2580	0.90	774
Triple-ring wok	Natural G20	20	150	—	416	4.0	3440	1.8	1548
	Butane G30	30	100	340	—	4.0	3440	1.8	1548

NOTICE:

- A. Before installation, make sure that the local distribution condition (nature of the gas pressure) and the setting of the appliance are compatible ”.
- B. "The setting conditions for this device are indicated on the classification label".
- C. "This gas plate is not connected to the combustion products evacuation device. It will be installed and connected in accordance with current installation regulations. Special attention will be given to the relevant requirements regarding ventilation. "
- D. "CAUTION: The use of a gas plate leads to the production of heat, humidity and combustion products in the room in which it is installed. Make sure the kitchen is well ventilated, especially when the plate is working: keep the natural ventilation openings or install a mechanical ventilation device. "