



# REFRIGERATOR

## *use & care*

Introduction.....	2	Controls and Settings.....	14
Important Safety information.....	3	Storage Features.....	17
Features.....	5	Care and Cleaning .....	18
Installation .....	7	Troubleshooting .....	19
Door Removal/Reversal.....	9	Limited Warranty .....	20
Door Handle Installation .....	13		

## Welcome to our family

Thank you for bringing Frigidaire into your home! We see your purchase as the beginning of a long relationship together.

This manual is your resource for the use and care of your product. Please read it before using your appliance. Keep it handy for quick reference. If something doesn't seem right, the troubleshooting section will help you with common issues.

FAQs, helpful tips and videos, cleaning products, and kitchen and home accessories are available at Frigidaire.com.

We are here for you! Visit our website, chat with an agent, or call us if you need help. We may be able to help you avoid a service visit. If you do need service, we can get that started for you.

Let's make it official! Be sure to register your product.

Keep your product info here so it's easy to find.

Model Number \_\_\_\_\_  
 Serial Number \_\_\_\_\_  
 Purchase Date \_\_\_\_\_

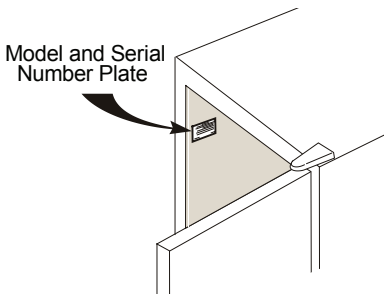

## Installation Checklist

### Doors

- Handles are secure and tight
- Door seals completely to cabinet on all sides
- Door is level from side to side across the top

### Leveling

- Appliance is level, side-to-side and tilted ¼" (6 mm) front-to-back
- Cabinet is setting solid on all corners
- Anti-tip bracket set in front (both sides)

### Electrical Power

- House power turned on
- Appliance plugged in

### Final Checks

- Shipping material removed
- Registration card sent in



## WARNING

Please read all instructions before using this appliance.

### Safety Definitions

This is the safety alert symbol. It is used to alert of potential personal injury hazards. Obey all safety messages that follow this symbol to avoid possible injury or death.



## DANGER

DANGER indicates an imminently hazardous situation which, if not avoided, will result in death or serious injury.



## WARNING

WARNING indicates a potentially hazardous situation which, if not avoided, could result in death or serious injury.



## CAUTION

CAUTION indicates a potentially hazardous situation which, if not avoided, may result in minor or moderate injury.



## IMPORTANT

IMPORTANT indicates installation, operation or maintenance information which is important but not hazard-related.



## DANGER



DANGER Risk of fire or explosion. Flammable refrigerant used. Do not use mechanical devices to defrost refrigerator. Do not puncture refrigerant tubing.

DANGER Risk of fire or explosion. Flammable refrigerant used. To be repaired only by trained service personnel. Use only manufacturer-authorized service parts. Any repair equipment used must be designed for flammable refrigerants. Follow all manufacturer repair instructions. Do not puncture refrigerant tubing.



## CAUTION



CAUTION Risk of fire or explosion. Dispose of refrigerator properly in accordance with the applicable federal or local regulations. Flammable refrigerant used.

CAUTION Risk of fire or explosion due to puncture of refrigerant tubing. Follow handling instructions carefully. Flammable refrigerant used.



## WARNING

WARNING! CALIFORNIA RESIDENTS  
Cancer and Reproductive Harm  
[www.P65Warnings.ca.gov](http://www.P65Warnings.ca.gov)

### Child Safety

This appliance is not intended for use by persons (including children) with reduced physical, sensory or mental capabilities, or lack of experience and knowledge, unless they have been given supervision or instruction concerning use of the appliance by a person responsible for their safety.

Destroy or recycle the carton, plastic bags, and any exterior wrapping material immediately after the unit is unpacked. Children should **NEVER** use these items to play. Cartons covered with rugs, bedspreads, plastic sheets or stretch wrap may become airtight chambers, and can quickly cause suffocation.

### Safety Instructions

- DO NOT store or use gasoline, or other flammable liquid within or in the vicinity of this appliance. Read Product Label for warnings regarding flammability and other hazards.
- DO NOT store explosive substances such as aerosol cans with a flammable propellant in this appliance.
- DO NOT operate the unit in the presence of explosive fumes.
- Avoid contact with any moving parts of automatic ice maker.
- Remove all staples from the carton. Staples can cause severe cuts, and also destroy finishes if they come in contact with other appliances or furniture.

# 4

## IMPORTANT SAFETY INFORMATION

### Proper Disposal of your Appliance

#### Risk of child entrapment

Child entrapment and suffocation are not problems of the past. Junked or abandoned appliances are still dangerous – even if they will sit for “just a few days”. If you are getting rid of your old appliance, please follow the instructions below to help prevent accidents.

We strongly encourage responsible appliance recycling/disposal methods. Check with your utility company or visit [energystar.gov/recycle](http://energystar.gov/recycle) for more information on recycling your old appliance.

#### Before you throw away your old appliance:

- Remove door.
- Leave shelves in place so children may not easily climb inside.
- Have refrigerant removed by a qualified service technician.

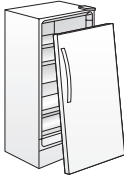

#### WARNING

These guidelines must be followed to ensure that safety mechanisms in this appliance will operate properly.

### Electrical information

- Plug the appliance into its own dedicated 115 Volt, 60 Hz., 15 Amp, AC only electrical outlet. The power cord of the appliance is equipped with a 3-prong grounding plug for your protection against electrical shock hazards. Plug it directly into a properly grounded 3-prong receptacle. Install the receptacle in accordance with local codes and ordinances. Consult a qualified electrician. Avoid connecting the appliance to a Ground Fault Interrupter (GFI) circuit. Do not use an extension cord or adapter plug.
- If the power cord is damaged, an authorized service technician should replace it to prevent any risk.
- Never unplug the appliance by pulling on the power cord. Always grip the plug firmly, and pull straight out from the receptacle to prevent damaging the power cord.

- Unplug the appliance before cleaning and before replacing the AC LED light bulb to avoid electrical shock. Use only a 5-watt or less AC LED light bulb.
- Performance may be affected if the voltage varies by 10% or more. Operating the appliance with insufficient power can damage the compressor. Such damage is not covered under your warranty.
- Do not plug the unit into an electrical outlet controlled by a wall switch or pull cord to prevent the appliance from being turned off accidentally.
- **WARNING:** Do not use electrical appliances inside the food storage compartments of the appliance unless they are recommended accessories for use within this model.

#### Grounding type wall receptacle

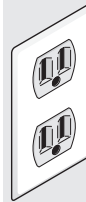

**Do not, under any circumstances, cut, remove, or bypass the grounding prong.**

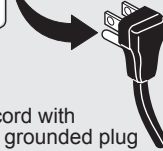

Power cord with 3-prong grounded plug



#### IMPORTANT

#### CFC/HCFC Disposal

Your old appliance may have a cooling system that used CFCs or HCFCs (chlorofluorocarbons or hydrochlorofluorocarbons). CFCs and HCFCs are believed to harm stratospheric ozone if released to the atmosphere. Other refrigerants may also cause harm to the environment if released to the atmosphere.

If you are throwing away your old appliance, make sure the refrigerant is removed for proper disposal by a qualified technician. If you intentionally release refrigerant, you may be subject to fines and imprisonment under provisions of environmental legislation.

\*Features may vary according to model

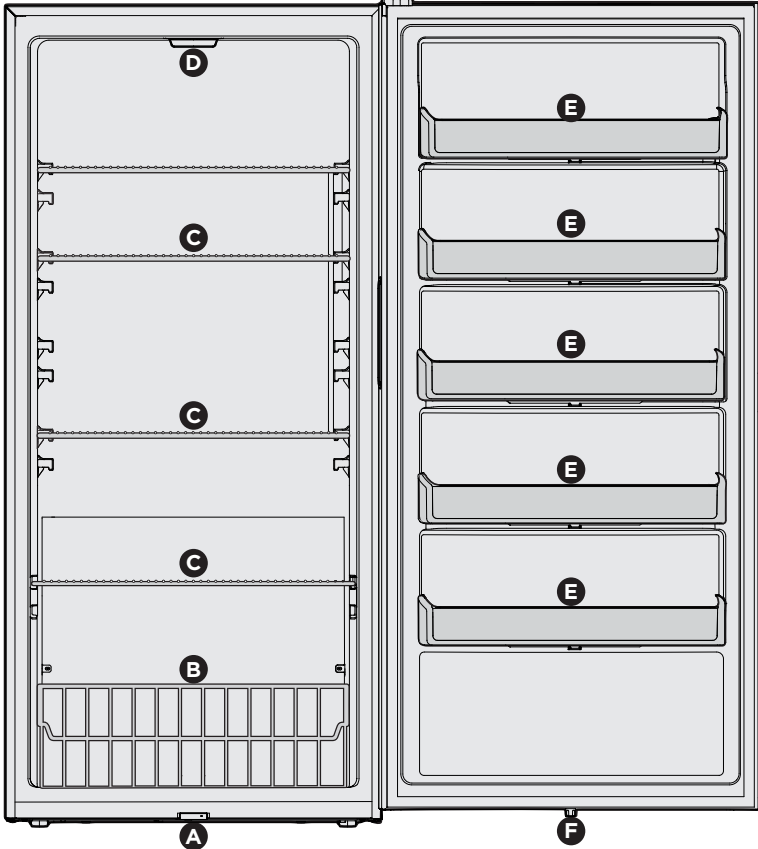

<b>A</b>	Magnetic Door Switch
<b>B</b>	Wire Refrigerator Basket
<b>C</b>	Refrigerator Shelf

<b>*D</b>	5-Watt AC LED Light Bulb
<b>E</b>	Fixed Door Bins
<b>*F</b>	Magnet (Door Open Sensor)



## IMPORTANT

### Cleaning your Appliance

Remove tape and glue residue from surfaces before turning on the appliance. Rub a small amount of liquid dish soap over the adhesive with your fingers. Rinse with warm water and dry with a soft cloth.

Do not use sharp instruments, rubbing alcohol, flammable fluids, or abrasive cleaners to remove tape or glue. These products can damage the surface of your appliance.

After you remove all of the package materials, clean the inside of your appliance before using it. See the **CARE & CLEANING** section in this manual.

See important information about cleaning glass shelves and covers in the **STORAGE FEATURES** section of this manual.

# 6

## FEATURES

---



### IMPORTANT

#### **Moving your Appliance**

Your appliance is heavy. When moving the appliance for cleaning or service, raise the anti-tip bracket (see **“Setting the anti-tip bracket”**). Be sure to cover the floor with cardboard or hardboard to avoid floor damage. Always pull the appliance straight out when moving it. Do not wiggle or “walk” the appliance when trying to move it as floor damage could occur.



### IMPORTANT

Accessories are available for your appliance and may be purchased at [Frigidaire.com](http://Frigidaire.com) or by calling 1-800-374-4432 (Frigidaire.ca or 1-800-265-8352 in Canada) or from an authorized seller.

This Use & Care Manual provides general operating instructions for your model. Use the appliance only as instructed in this Use & Care Manual. Before starting the appliance, follow these important first steps.

## Location

- Choose a place that is near a grounded electrical outlet. Do Not use an extension cord or an adapter plug.
- If possible, place the appliance out of direct sunlight and away from the range, dishwasher or other heat sources.
- Install the appliance on a floor that is level and strong enough to support a fully loaded appliance.



### WARNING

DO NOT install the appliance where the temperature will drop below 35°F (1.7°C) or rise above 110°F (43°C). The compressor will not be able to maintain proper temperatures inside the unit.



### CAUTION

Do not block the lower front of your appliance. Sufficient air circulation is essential to operate your appliance properly.

## Installation

### Installation clearances

- Allow the following clearances for ease of installation, proper air circulation, and plumbing and electrical connections:

Sides & Top	$\frac{3}{8}$ in.
Back	1 in.



### NOTE

If your appliance is placed with the door hinge side against a wall, you may have to allow additional space for the handle so the door can be opened wider.

### Guidelines for final positioning of your appliance:

- All 4 corners of the cabinet must rest firmly on the floor.
- The cabinet should be level at the front and rear.
- The door should be level.

### Setting the anti-tip bracket:

Models are equipped with an anti-tip bracket. The anti-tip brackets are located on the lower front corners of the cabinet. Lower the anti-tip on each side clockwise until they contact the floor. Do not raise the cabinet.

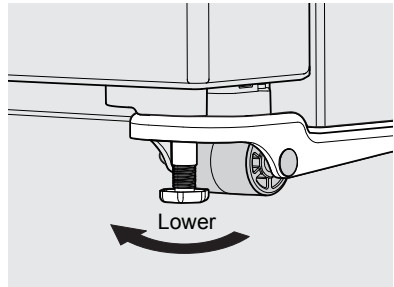

Anti-tip Bracket



### WARNING



The anti-tip device must be installed according to the instructions in your Use & Care Manual. Failure to do so may result in injury.

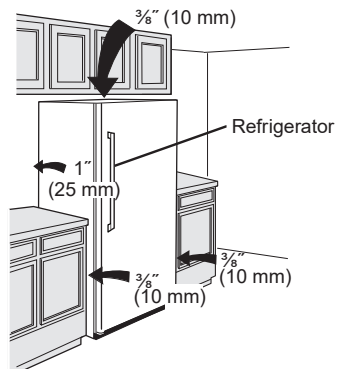

# 8

## INSTALLATION

---

### Pairing Installation



#### IMPORTANT

Read before installation

If you are installing the following appliances next to each other, a pairing kit (TWINPAIRKIT) is REQUIRED to complete the installation. To obtain this kit, please contact the retailer where you purchased your appliances, or contact Frigidaire customer service at 1-800-374-4432 in the US, 1-800-265-8352 in Canada.



All Freezer and All Refrigerator



2 All Refrigerators\*



#### NOTE

\*In the configuration shown, one door has been reversed to have both handles in the middle. See **DOOR REMOVAL/REVERSAL**.



## Tools Necessary:

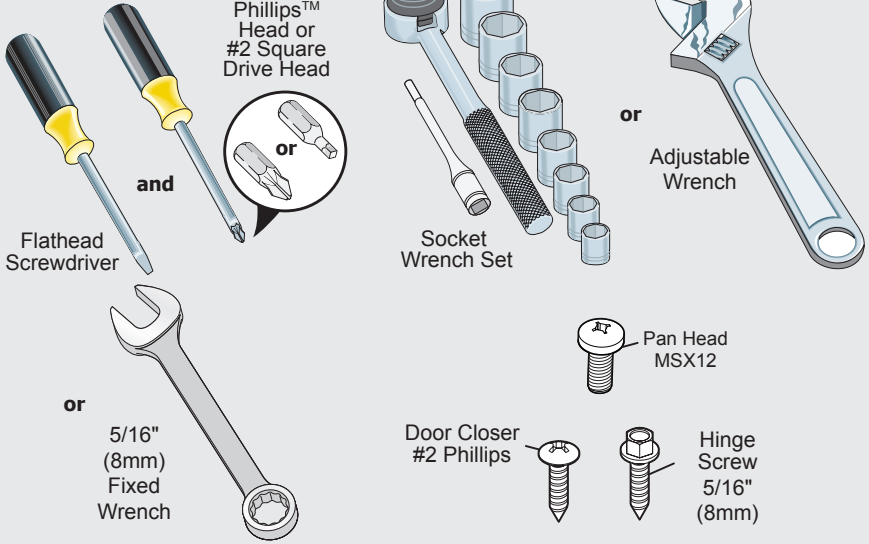

## NOTE

The direction in which your appliance doors open (door swing) can be reversed, from left to right or right to left, by moving the door hinges from one side to the other. Reversing the door swing should be performed by a qualified person.

1. Unplug your appliance.
2. Lay the unit down on its back.
3. Disconnect the small blue and white connectors located in the channel in the bottom of the door (see Figure 1A).
4. Remove the gray cable from underneath the 2 harness retaining clips (see Figure 1B).

## IMPORTANT

Before you begin, turn the appliance temperature control to "off" and remove the electrical power cord from the wall outlet. Remove any food from door shelves.

## CAUTION

This procedure will require 2 people to safely perform.

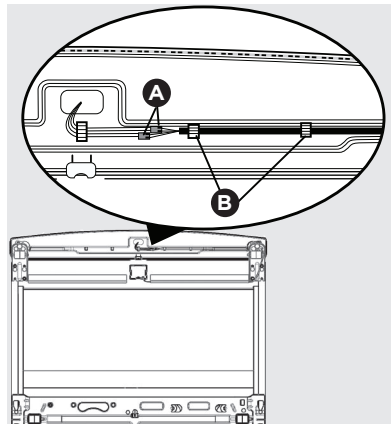

Figure 1

# 10

## DOOR REMOVAL/REVERSAL

5. Pull the gray cable and connectors through the hinge hole located on the bottom of the cabinet using a flat-head screwdriver.
6. Route the gray cable and the connectors out from under the wheel axle and the wheel spacer (see Figure 2).

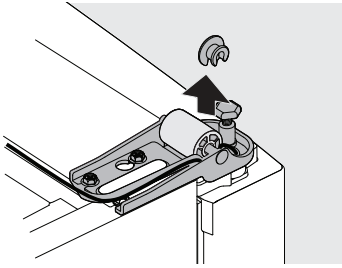

Figure 2

7. Slide the gray cable and connectors out of the plastic channel located on the bottom right side of the cabinet (see Figure 3).

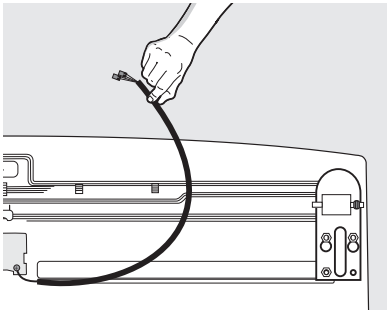

Figure 3

8. Remove the bottom hinge using 5/16" (8mm) wrench (see Figure 4).

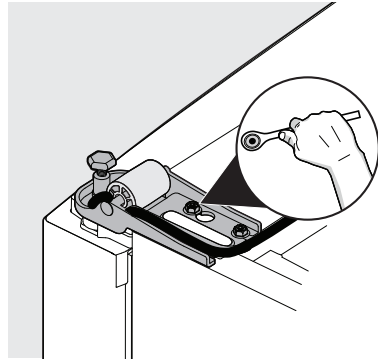

Figure 4

9. Using a Phillips™ screwdriver, remove the screws from the hinge bearing and the door closer (see Figure 5A).
10. Using a flathead screwdriver, gently pry the door closer/hinge bearing assembly out of the door (see Figure 5B).
11. Separate the door closer and hinge bearing (see Figure 5C).
12. Flip the door closer over 180° and reinstall the door closer onto the hinge bearing (see Figure 5D).
13. Using a Phillips™ screwdriver, attach the door closer/hinge bearing assembly to the opposite side of the door (see Figure 5E).

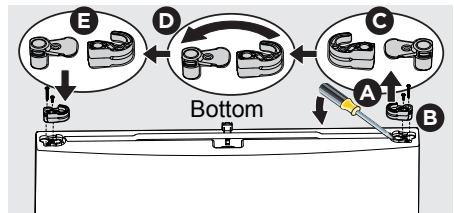

Figure 5

14. Remove the screw from the door stop located on the bottom hinge, using a Phillips™ screwdriver (see Figure 6A).
15. Using a flathead screwdriver, gently pry the door stop off the bottom hinge pin (see Figure 6B)
16. Using an adjustable wrench, remove the bottom hinge pin and install into the left hole (see Figure 6C) .
17. Flip the door stop over 180° and reinstall onto the bottom hinge pin. Secure the door stop with the screw (see Figure 6D).

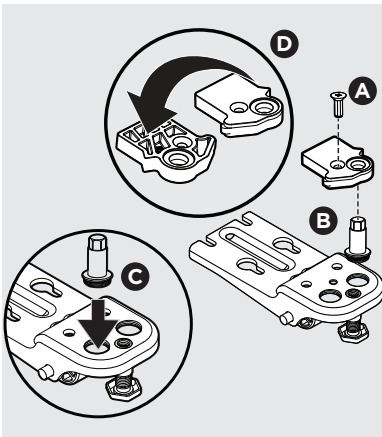

Figure 6

18. Remove the left bottom hinge using 5/16" (8 mm) wrench and install on the right side. Figure 7.

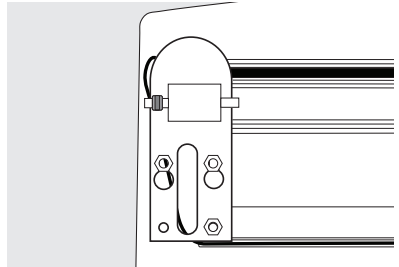

Figure 7

19. Reattach the bottom hinge (with the door stop) to the left side of the cabinet and add the wheel spacer on the left side of the wheel axle.
20. Route the gray cable and connectors through the left side plastic channel (see Figure 8A).
21. Route the gray cable and connectors under the left side wheel axle and wheel spacer (see Figure 8B).
22. Route the connectors and gray cable through the left side hole in the hinge (see Figure 8C).
23. Insert the gray cable into the left side door channel in the bottom of the door (see Figure 8D).

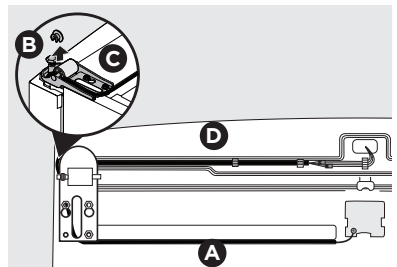

Figure 8

# 12

## DOOR REMOVAL/REVERSAL

24. Route the gray cable underneath the 2 harness retaining clips on the left side of the door channel.
25. Reconnect the blue and white connectors.
26. Remove the hinge cover (see Figure 9A) and use a 5/16" wrench to remove the top hinge (see Figure 9B).

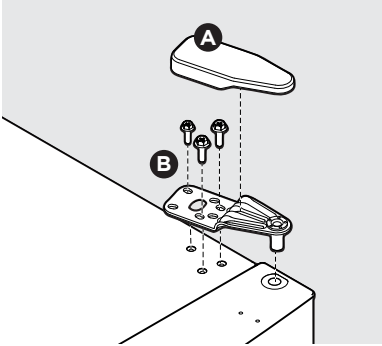

Figure 9

27. Pry out the hinge bearing from the top of the door with a flathead screwdriver (see Figure 10A). Install the hinge bearing on the opposite side of the door (see Figure 10B).

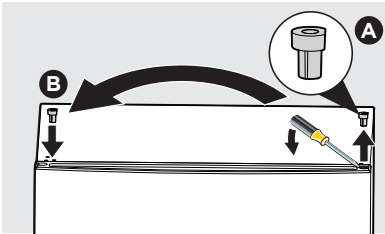

Figure 10

28. Reattach the top hinge (B) onto the left side of the cabinet, using a 5/16" wrench. Replace the top hinge cover (A) (see Figure 11).

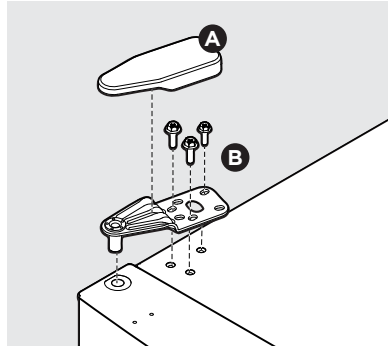

Figure 11



### CAUTION

Raise the appliance to the upright position and allow 1 hour before plugging the unit back into electrical outlet.

29. Plug the power cord back into the electrical outlet.



## CAUTION

Wear gloves and use extreme CAUTION when installing these handles. The rounded end of the handles may be sharp.



## IMPORTANT

To ensure proper installation of handle, please review these instructions and illustrations thoroughly prior to installing the handle.

Additionally, before installing the door handle, make sure the door swing is correct. Your model will have either a right-hand or left-hand door swing. Follow instructions in the Use & Care Manual to reverse the doors, if necessary.

1. Remove the handle from the carton and any other protective packaging.
2. Position the handle end caps over upper and lower pre-installed shoulder bolts (A) that are fastened into door, ensuring the holes for the set screws are facing towards the hinge.
3. While holding handle firmly against door, fasten the upper and lower Allen set screws (B) with the supplied Allen wrench.

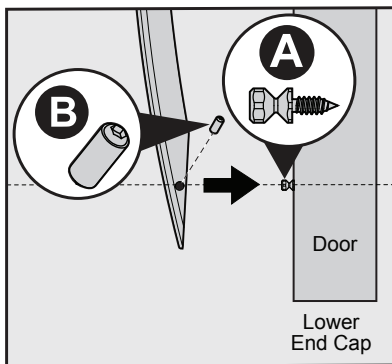
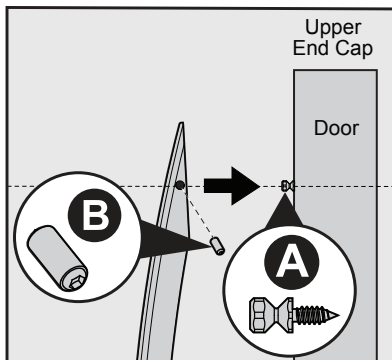

# 14 CONTROLS AND SETTINGS

## FRIGIDAIRE

High Temp

Chill  
Boost

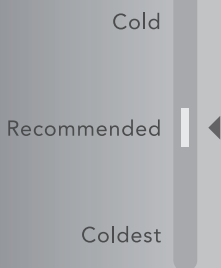

Temp

Hold To Clear Alert

### Cool Down Period

To ensure safe food storage, allow the appliance to operate with the door closed for at least 8 hours before loading it with food.

### Power On

Plugging in the appliance for the first time causes the LED Power On light to illuminate. An audible alert will sound.

### Appliance Control

#### NOTE

Pressing the **Temp** button will scroll through the 5 temperature settings toward the coldest setting (bottom), and then loop back to the least coldest setting (top).

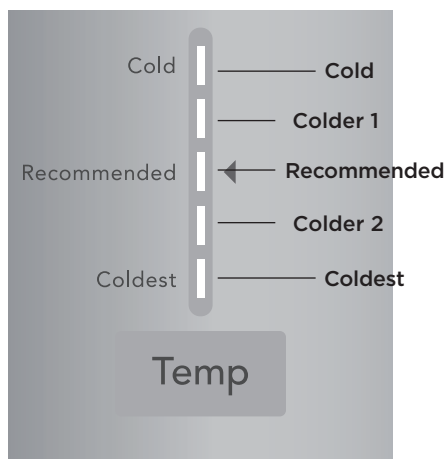

### Temperature Adjustment

Adjust the temperature gradually: adjust the setting in small increments, allowing the temperature to stabilize.

- For colder temperatures, adjust the setting to **Coldest**.
- For warmer temperatures, adjust the setting to **Cold**.

**Chill Boost**

Prior to grocery shopping. Activate Chill Boost so upon returning you can ensure you newly purchased refrigerated food will stay preserved longer.

Turning on **Chill Boost** will cool the appliance down to a target temperature. It will remain active for up to 6 hours before automatically deactivating or being manually exited. To turn the function off, press **Chill Boost**. When the function is turned off, it will automatically set the appliance back to the previous temperature setting.

**High Temp**

If the temperature inside the cabinet exceeds above cooling your food, the High Temp LED light on your user interface will illuminate and the alarm will sound. The alarm can be reset by pressing and holding the Temp button for 3 seconds.



**IMPORTANT**

If the high temp condition has not improved after a period of time, the alert will be displayed again. In this event, repeat steps for resetting the alert and call Frigidaire at 1-800-374-4432 for assistance.

**Power failure**

In the event of a power failure, where the temperature increases above cooling your food, once you restore power, the red HIGH Temp led light will illuminate, and the alarm will sound. Reset the alarm by pressing and holding the Temp button for 3 seconds.

**Door Ajar**

This alert will sound to alert you that the door has been open for 5 minutes or more. The audible alert will sound until the door is closed. The alarm can be reset by pressing and holding the Temp button for 3 seconds.

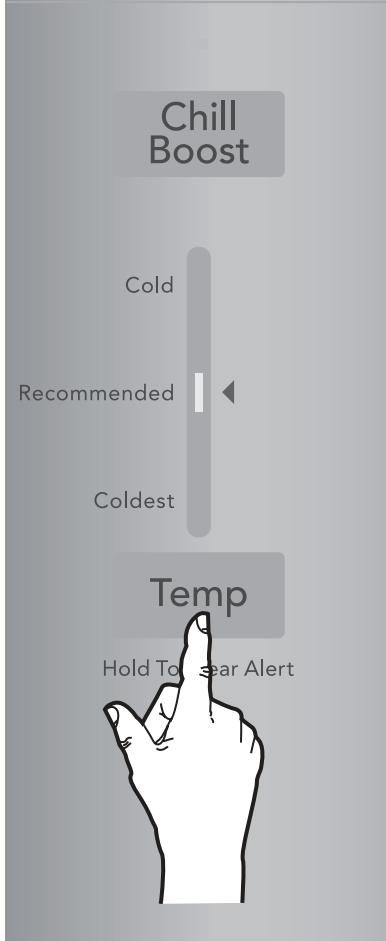
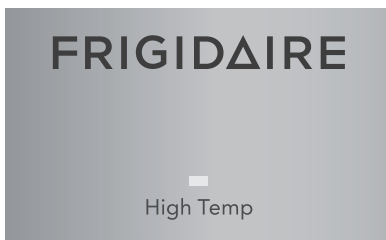
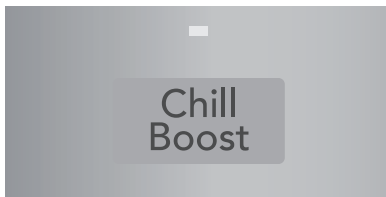

## Sabbath Mode

The Sabbath Mode is a feature that disables portions of the appliance and its controls in accordance with observance of the weekly Sabbath and religious holidays within the Orthodox Jewish community.

All buttons are disabled, and all sounds (except the High Temp alert\*) are muted. Only the High Temp alert will illuminate until you deactivate the Sabbath Mode.

### NOTE

The temperature setting is not affected by the Sabbath Mode. For food safety, the High Temp alert will sound for 10 minutes if the internal temperature increases. After 10 minutes, the alarm will stop, but the High Temp LED will remain lit until you deactivate the Sabbath Mode.

### NOTE

While in Sabbath Mode, neither the lights nor the control panel will work (except to exit Sabbath Mode) until Sabbath Mode is deactivated.

The appliance stays in Sabbath Mode after power failure recovery. It must be deactivated with the buttons on the control panel.

### To enter Sabbath Mode

Press and hold the **Temp** and **Chill Boost** buttons simultaneously for 5 seconds. One LED on each side of **Recommended** setting will be lit while the unit is in Sabbath mode.

**To exit Sabbath Mode**, repeat the steps above.



**Sabbath Mode  
activated**

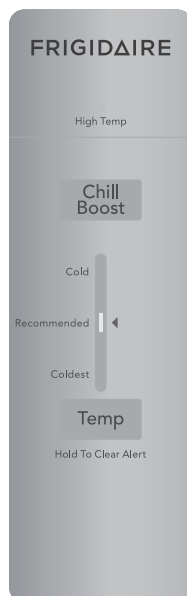

**Sabbath Mode  
deactivated**



For further assistance, guidelines for proper use and a complete list of models with the Sabbath feature, please [star-k.org](http://star-k.org).



## Shelf Adjustment

Easily adjust appliance shelves to suit individual needs. Before adjusting the shelves, remove all food.

**To adjust shelves,** lift the front of the shelf and pull forward.

**To replace shelves,** insert the rear of the shelf into any pair of shelf rails and carefully push the shelf back into position, making sure the shelf clips go in the notch in the liner.

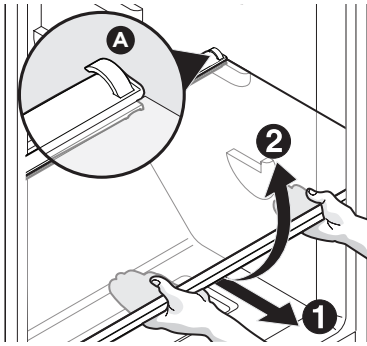

Glass Shelf

## Door Storage

Door bins and shelves conveniently store jars, bottles, and cans. You can quickly select frequently used items.

### To remove the door bin:

1. Push in on each side of the door bin to release it from the locking tabs.
2. Lift up on the bin and pull it straight out.

### To install the door bins:

1. Push the bin back and down into the locking tabs.
2. The bin sides will lock into the tabs.

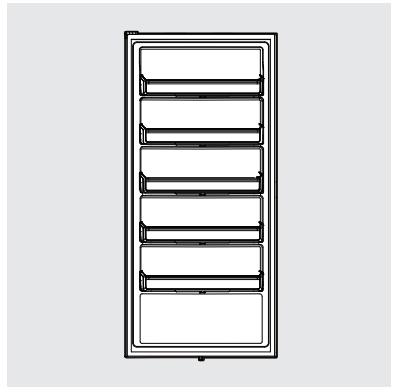

## Basket (some models)

The basket is ideal for large items or items that do not store well on the shelves.

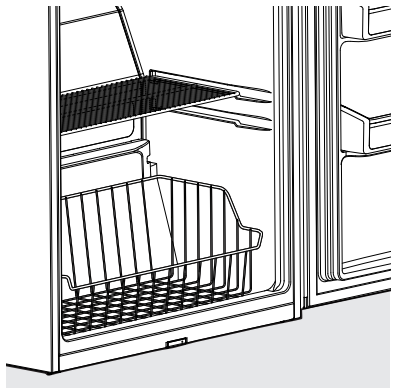

# 18 CARE AND CLEANING

## Protecting your investment

Keeping your appliance clean maintains appearance and prevents odor build-up. Wipe up any spills immediately and clean the appliance at least twice a year. When cleaning, take the following precautions:

- Never use CHLORIDE or cleaners with bleach to clean stainless steel.
- Do not wash any removable parts in a dishwasher.
- Always unplug the electrical power cord from the wall outlet before cleaning.
- Remove adhesive labels by hand. Do not use razor blades or other sharp instruments which can scratch the appliance surface.
- Do not remove the serial plate.

Do not use abrasive cleaners such as window sprays, scouring cleansers, brushes, flammable fluids, cleaning waxes, concentrated detergents, bleaches or cleansers containing petroleum products on plastic parts, interior doors, gaskets or cabinet liners. Do not use paper towels, metallic scouring pads, or other abrasive cleaning materials or strong alkaline solutions.



### NOTE

If you set your temperature controls to turn off cooling, power to lights and other electrical components will continue until you unplug the power cord from the wall outlet.



### CAUTION

- Pull the appliance straight out to move it. Shifting it from side to side may damage flooring.
- Damp objects stick to cold metal surfaces. Do not touch refrigerated surfaces with wet or damp hands.

## Care & Cleaning Tips

Part	What To Use	Tips and Precautions
Interior & Door Liner	<ul style="list-style-type: none"> <li>• Soap and water</li> <li>• Baking soda and water</li> </ul>	Use 2 tbsp of baking soda in 1 qt of warm water. Be sure to wring excess water out of sponge or cloth before cleaning around controls, light bulb or any electrical part.
Door Gasket	<ul style="list-style-type: none"> <li>• Soap and water</li> </ul>	Wipe gaskets with a clean soft cloth.
Exterior	<ul style="list-style-type: none"> <li>• Soap and water</li> </ul>	<b>NOTE:</b> Wash the appliance with warm water and mild liquid detergent. Rinse well, and wipe dry with a clean soft cloth.
Replacing AC LED Light Bulb	<ul style="list-style-type: none"> <li>• Unplug appliance</li> <li>• Wear gloves</li> <li>• Remove light cover</li> <li>• Replace old bulb</li> <li>• Replace light cover</li> <li>• Plug in the appliance</li> </ul>	<p><b>CAUTION:</b> Wear gloves when replacing the 5-watt AC LED light bulb to avoid getting cut. Use same wattage when replacing the bulb.</p> <p><b>CAUTION:</b> Use only a 5-watt or less AC LED light bulb.</p>

Let us help you troubleshoot your concern! This section will help you with common issues. If you need us, visit our website, chat with an agent, or call us. We may be able to help you avoid a service visit. If you do need service, we can get that started for you!

**1-800-374-4432 (United States)**

**1-800-265-8352 (Canada)**

**Frigidaire.com**

**Frigidaire.ca**

<b>Common Occurrences</b>	Before calling for service, review this list. It may save you time and expense. This list includes common occurrences that are not the result of defective workmanship or materials in this appliance.
Appliance does not run.	<ul style="list-style-type: none"> <li>• Ensure plug is tightly pushed into electrical outlet.</li> <li>• Check/replace fuse with a 15-amp time-delay fuse. Reset circuit breaker.</li> <li>• The appliance control is turned to “<b>OFF</b>”.</li> <li>• Appliance may be in defrost cycle. Wait 20 minutes and check again.</li> </ul>
Appliance temperature is unsatisfactory.	<ul style="list-style-type: none"> <li>• Check the appliance temperatures and adjust the temperature control as needed.</li> </ul>
Appliance temperature is warmer than preferred.	<ul style="list-style-type: none"> <li>• Set control to a colder setting until appliance temperature is satisfactory. Allow 24 hours for the temperature to stabilize.</li> </ul>
Appliance is noisy or vibrates.	<ul style="list-style-type: none"> <li>• The cabinet is not level.</li> <li>• Adjust the anti-tip bracket. See “<b>Setting the anti-tip bracket</b>” in the <b>INSTALLATION</b> section.</li> <li>• Floor is weak.</li> </ul>
Odors in appliance.	<ul style="list-style-type: none"> <li>• Interior needs to be cleaned.</li> <li>• Foods that produce odors should be covered or wrapped.</li> </ul>
Cabinet light not working.	<ul style="list-style-type: none"> <li>• Replace AC LED light bulb. <b>Caution:</b> Use only a 5-Watt or less AC LED light bulb.</li> <li>• Ensure plug is tightly pushed into electrical outlet.</li> </ul>

# 20

## LIMITED WARRANTY

Your appliance is covered by a one year limited warranty. For one year from your original date of purchase, Electrolux will pay all costs for repairing or replacing any parts of this appliance that prove to be defective in materials or workmanship when such appliance is installed, used and maintained in accordance with the provided instructions.

### Exclusions

#### This warranty does not cover the following:

1. Products with original serial numbers that have been removed, altered or cannot be readily determined.
2. Product that has been transferred from its original owner to another party or removed outside the USA or Canada.
3. Rust on the interior or exterior of the unit.
4. Products purchased "as-is" are not covered by this warranty.
5. Food loss due to any Appliance or freezer failures.
6. Products used in a commercial setting.
7. Service calls which do not involve malfunction or defects in materials or workmanship, or for appliances not in ordinary household use or used other than in accordance with the provided instructions.
8. Service calls to correct the installation of your appliance or to instruct you how to use your appliance.
9. Expenses for making the appliance accessible for servicing, such as removal of trim, cupboards, shelves, etc., which are not a part of the appliance when it is shipped from the factory.
10. Service calls to repair or replace appliance light bulbs, air filters, water filters, other consumables, or knobs, handles, or other cosmetic parts.
11. Surcharges including, but not limited to, any after hour, weekend, or holiday service calls, tolls, ferry trip charges, or mileage expense for service calls to remote areas, including the state of Alaska.
12. Damages to the finish of appliance or home incurred during installation, including but not limited to floors, cabinets, walls, etc.
13. Damages caused by: services performed by unauthorized service companies; use of parts other than genuine Electrolux parts or parts obtained from persons other than authorized service companies; or external causes such as abuse, misuse, inadequate power supply, accidents, fires, or acts of God.

### DISCLAIMER OF IMPLIED WARRANTIES; LIMITATION OF REMEDIES

CUSTOMER'S SOLE AND EXCLUSIVE REMEDY UNDER THIS LIMITED WARRANTY SHALL BE PRODUCT REPAIR OR REPLACEMENT AS PROVIDED HEREIN. CLAIMS BASED ON IMPLIED WARRANTIES, INCLUDING WARRANTIES OF MERCHANTABILITY OR FITNESS FOR A PARTICULAR PURPOSE, ARE LIMITED TO ONE YEAR OR THE SHORTEST PERIOD ALLOWED BY LAW, BUT NOT LESS THAN ONE YEAR. ELECTROLUX SHALL NOT BE LIABLE FOR CONSEQUENTIAL OR INCIDENTAL DAMAGES SUCH AS PROPERTY DAMAGE AND INCIDENTAL EXPENSES RESULTING FROM ANY BREACH OF THIS WRITTEN LIMITED WARRANTY OR ANY IMPLIED WARRANTY. SOME STATES AND PROVINCES DO NOT ALLOW THE EXCLUSION OR LIMITATION OF INCIDENTAL OR CONSEQUENTIAL DAMAGES, OR LIMITATIONS ON THE DURATION OF IMPLIED WARRANTIES, SO THESE LIMITATIONS OR EXCLUSIONS MAY NOT APPLY TO YOU. THIS WRITTEN WARRANTY GIVES YOU SPECIFIC LEGAL RIGHTS. YOU MAY ALSO HAVE OTHER RIGHTS THAT VARY FROM STATE TO STATE.

### If You Need Service

Keep your receipt, delivery slip, or some other appropriate payment record to establish the warranty period should service be required. If service is performed, it is in your best interest to obtain and keep all receipts. Service under this warranty must be obtained by contacting Electrolux at the addresses or phone numbers below.

This warranty only applies in the USA and Canada. In the USA, your appliance is warranted by Electrolux Major Appliances North America, a division of Electrolux Home Products, Inc. In Canada, your appliance is warranted by Electrolux Canada Corp. Electrolux authorizes no person to change or add to any obligations under this warranty. Obligations for service and parts under this warranty must be performed by Electrolux or an authorized service company. Product features or specifications as described or illustrated are subject to change without notice.

**USA**  
**1-800-374-4432**  
Frigidaire  
10200 David Taylor Drive  
Charlotte, NC 28262



**Electrolux**

**Canada**  
**1.800.265.8352**  
Electrolux Canada Corp.  
5855 Terry Fox Way  
Mississauga, Ontario, Canada  
L5V 3E4

# FRIGIDAIRE®

welcome *home*

Our home is your home. Visit us if you need help with any of these things:



owner support



accessories



service



registration

(See your registration card for more information.)

Frigidaire.com  
1-800-374-4432

Frigidaire.ca  
1-800-265-8352