

marantz

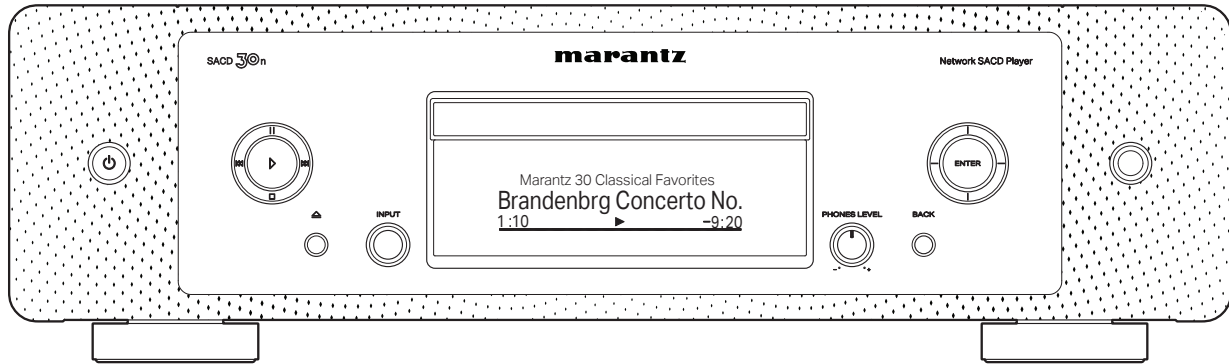

SACD 30n | Network SACD Player

QUICK START GUIDE

Welcome

Thank you for choosing a Marantz network SACD player. This guide provides step-by-step instructions for setting up your network SACD player.

Before You Begin

What's In the Box

Quick Start Guide

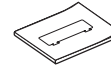

Remote control unit (RC002PMND)

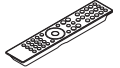

Safety Instructions

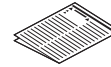

R03/AAA batteries



Notes on radio

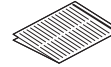

Audio cable



Warranty (for USA/for CANADA)

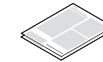

Remote connector cable



Network SACD Player



External antennas for Bluetooth/wireless connectivity



Power cord



Required for Setup

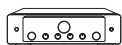

Amplifier



Speaker systems



Speaker cables



Wi-Fi Router

or



LAN cable

Optional



Computer



USB cable



Mobile device



These drawings are for illustrative purposes only and may not represent the actual product(s).

! Important: External Antennas

The external antennas are required for both Bluetooth and Wireless network connectivity. Please make sure to connect the antennas before attempting to use the Bluetooth or Wi-Fi features of the SACD 30n.

Connect the external antennas for Bluetooth/Wireless connectivity

For each of the two antennas:

- ① Place the antenna evenly over the antenna terminal located at the upper left or right corner of the rear panel.
- ② Turn the antenna clockwise until it is fully connected. Do not over tighten.
- ③ Rotate the antenna upwards for the best possible reception.

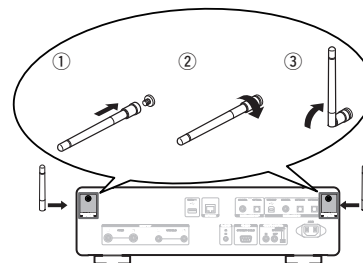

Setup

There are seven steps to the setup process.

- 1 Install batteries in the remote control unit
 - 2 Connect this unit to the amplifier
 - 3 Plug the power cord into a power outlet
 - 4 Connect this unit to the network
 - 5 Enjoy your music
 - 6 Enjoy your music using the HEOS App
 - 7 Listen to computer audio via USB-DAC
 - 1) Install the Windows driver software
 - 2) Connect to PC or Mac
 - 3) Listen to audio from PC or Mac
-

1 Install batteries in the remote control unit

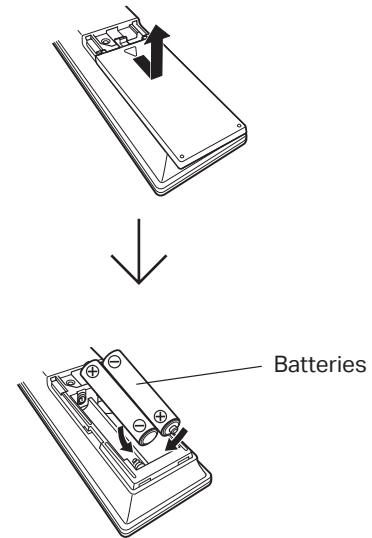

2 Connect this unit to the amplifier

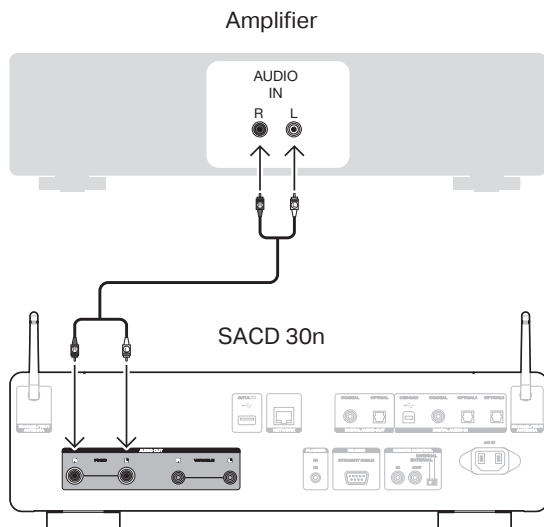



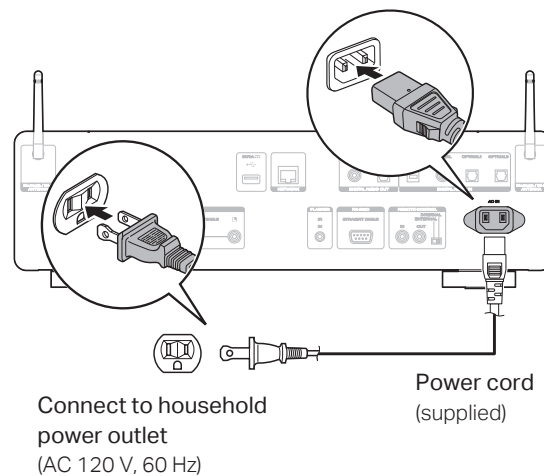





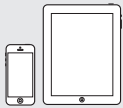

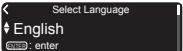





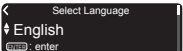

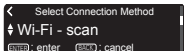
3 Plug the power cord into a power outlet

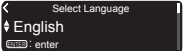

4 Connect this unit to the network

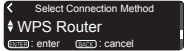
Choose from one of the following options.

<p>Wireless</p> <p>iOS device iOS version 7 or later</p> 	<p>1 Power on.</p> 	<p>2 Select language. (After selecting a language, please be patient while the network settings initialize. Expect to wait a few minutes.)</p>  	<p>3 Make sure your iOS device is connected to your Wi-Fi Network. Select the network named "Marantz SACD30n" from the Settings/Wi-Fi screen on your device.</p>  
<p>No WPS router</p>  <p>Wi-Fi router</p>	<p>1 Power on.</p> 	<p>2 Select language. (After selecting a language, please be patient while the network settings initialize. Expect to wait a few minutes.)</p>  	<p>3 Select "Wi-Fi - scan" and wait as your SACD 30n looks for available networks.</p>  
<p>WPS router</p>   <p>Wi-Fi router</p>	<p>1 Power on.</p> 	<p>2 Select language. (After selecting a language, please be patient while the network settings initialize. Expect to wait a few minutes.)</p>  	<p>3 Select "WPS Router".</p>  

Wired

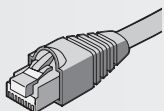

- 1 Connect a network cable between your SACD 30n and your router.
(cable not included)
- 2 Power on.
- 3 Select language.
- 4 Please wait while your SACD 30n connects to your wired network.



Connected !

- 4 Follow the instructions and tap Next.



- 5 Please wait as completing the connection can take a few minutes.
(The front panel of the SACD 30n will show the status of the connection.)

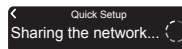

- 4 Select your network name.
(If your network name is not listed, select "Rescan".)



- 5 Enter your network password using the number keys on the remote control.

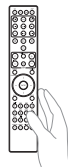
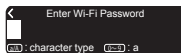

**Wi-Fi
Connected !**

Press the ENTER button.



If the signal strength of your wireless network is weak, to improve reception, please turn the antenna on the back of your SACD 30n or move your router to the SACD 30n.

- 4 Press the WPS button on your router.
Within 2 minutes, press the ENTER button.



- 5 Please wait as completing the connection can take a few minutes.
(The front panel of the SACD 30n will show the status of the connection.)

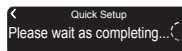

Auto-Update Setting

- 1 Turns on Auto-Update so that future updates are automatically downloaded and installed when your SACD 30n is in standby mode.

Select "On" to turn on Auto-Update.

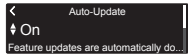

Select "Off" to turn off Auto-Update.

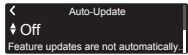

- 2 Sets the time zone that matches the area where you live.

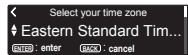

Usage Data Setting

To help us improve our products and customer service, Marantz collects anonymous information about how you use your SACD 30n. Marantz will never provide any information we collect to third parties.

Select "Yes" to provide information on the operating status of this unit.

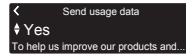

Select "No" to not provide information on the operating status of this unit.

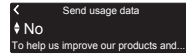

Setup Complete!

5 Enjoy your music

Enjoy Internet Radio

- 1 Press INTERNET RADIO.
- 2 Select the station you want to play, then press ENTER.
- 3 Select "Play Now", then press ENTER.



Enjoy music using Apple AirPlay

- 1 Open Control Center then tap the AirPlay icon in the audio card.
- 2 Select "Marantz SACD30n" from the AirPlay Device list.
- 3 Choose music to play from your iPhone, iPod touch, or iPad.



You can also AirPlay audio from an app you're using on your iOS device. Just open the app, tap the AirPlay icon, then tap a speaker or tap multiple speakers.

Enjoy music using Bluetooth

1 Press Bluetooth to select Bluetooth.

When using for the first time, the unit will go into the pairing mode automatically and "Bluetooth Pairing Mode" will appear on the display of the unit.

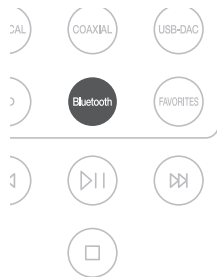
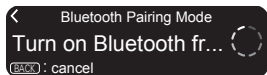

2 Activate Bluetooth on your mobile device.

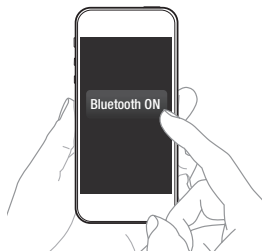

3 Select "Marantz SACD30n" from the Bluetooth device list on your mobile device.

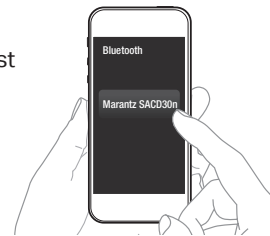

4 Play music using any app on your device.

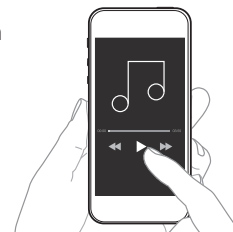

 To pair with other Bluetooth devices, press and hold Bluetooth on the remote control until "Bluetooth Pairing Mode" is displayed on the unit.

6 Enjoy your music using the HEOS App



The HEOS App lets you control your SACD 30n effortlessly to explore, browse, and play music from many online streaming services or from your own music library.

1 Download and open the HEOS App.

Scan the QR code and download the HEOS App on your mobile device. Then open the HEOS App.



NOTE

To control the SACD 30n with HEOS App, your device must be connected to the same network. Refer to instructions on Step 4 "Connect this unit to the network" to connect your device to a network.

2 Create a HEOS account or sign in using your HEOS account.

- ① Tap "Music" in the navigation tab.
- ② Select the Settings icon  in the upper left corner of the screen.
- ③ Select "HEOS Account".

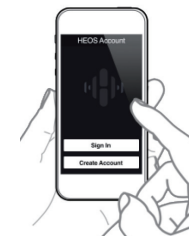

3 Tap "Rooms" in the navigation tab.

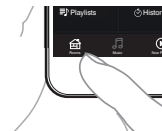

4 Select "Marantz SACD30n" from the "Rooms" list.



5 Sync services on the “Music” Screen.

Sign in to your favorite online streaming services or choose from your own music library to sync music to your HEOS account.

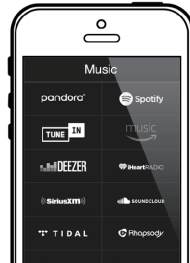

6 Play your music and enjoy.

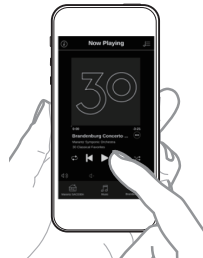

7 Listen to computer audio via USB-DAC

1 Install the Windows driver software

NOTE

The installation of the driver software is not necessary in the following cases.

- When you do not play back the music from a PC using USB-DAC of this unit.
- When using a macOS.

The driver software cannot be installed correctly if your PC is connected to the unit by a USB cable. If the unit and your computer are connected by a USB cable and the computer is switched on before installation, disconnect the USB and restart the computer.

Windows OS

System requirements : Windows 8.1 or Windows 10

- 1 Download the dedicated driver from the "Download" section of the SACD 30n page of the Marantz website (<http://www.marantz.com/pages/home.aspx>) onto your PC.
- 2 Unzip the downloaded file, and double-click the exe file.

3 Install the driver.

- 1 Select the language to use for the installation.
- 2 Click "OK".

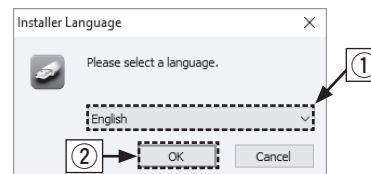

- 3 The wizard menu is displayed. Follow the instructions on the screen.
- 4 When the wizard is completed, click "Yes".



NOTE

Please see the FAQ at www.marantz.com if you experience any issues getting audio to play from your computer through the SACD 30n. You may also want to check the support pages for audio player application.



2 Connect to PC or Mac

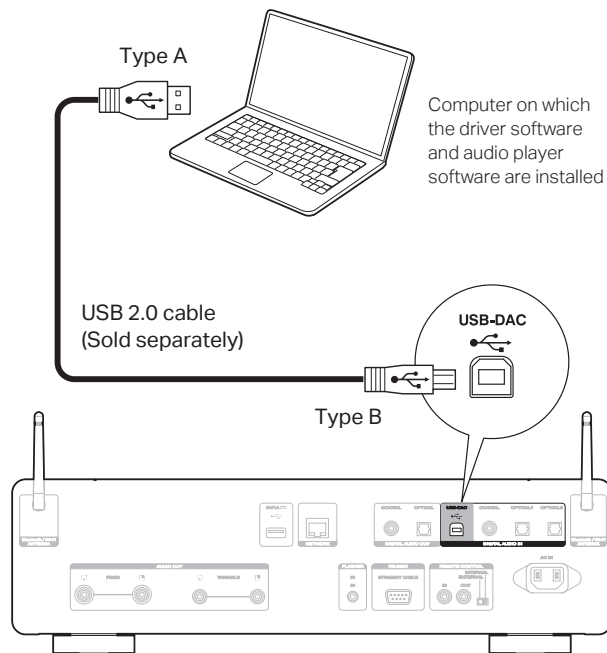

3 Listen to audio from PC or Mac

- 1 Power on.
- 2 Press USB-DAC to switch the input source to "USB-DAC".
- 3 Set the audio signal destination to this unit on the computer.



Windows OS

- 1 Click the "Start" button and click "Control Panel" on the PC.
 - The control panel setting list is displayed.
- 2 Click the "Sound" icon.
 - The sound menu window is displayed.

- ③ Check that there is a checkmark next to “Default Device” under in “SACD 30n” of the “Playback” tab.
 - When there is a checkmark for a different device, click “SACD 30n” and “Set Default”.
- ④ Select “SACD 30n” and click “Properties”.
 - The SACD 30n Properties window is displayed.

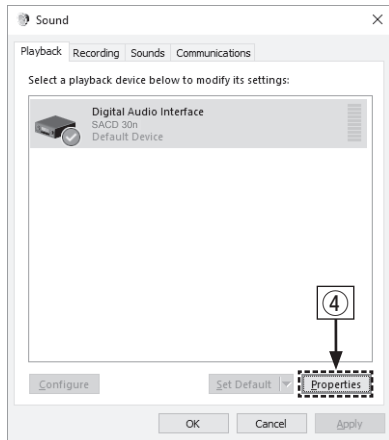

- ⑤ Click the “Advanced” tab.
- ⑥ Select the sampling rate and bit rate to be applied to the D/A converter.
 - It is recommended that “2 channel, 32 bit, 192000 Hz (Studio Quality)” is selected.
- ⑦ Click “Apply”.
- ⑧ Click “Test”.
- Check that audio from this unit is output from the PC.

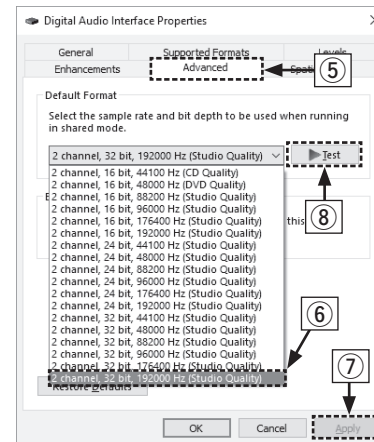

macOS

System requirements: macOS 10.13, 10.14 and 10.15

- ① Move the cursor to “Go” on the computer screen, and then click “Utilities”.
 - The utility list is displayed.
- ② Double-click “Audio MIDI Setup”.
 - The “Audio Devices” window is displayed.
- ③ Check that “Use this device for sound output” is checked in “SACD 30n”.
 - If a different device is checked, select and “Secondary click” on “SACD 30n”, and then select “Use this device for sound output”.

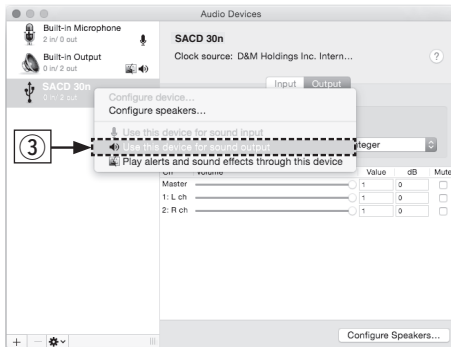

- ④ Select the “SACD 30n” format.
 - It is normally recommended to set the format to “384000.0 Hz” and “2ch-32 bit Interger”.

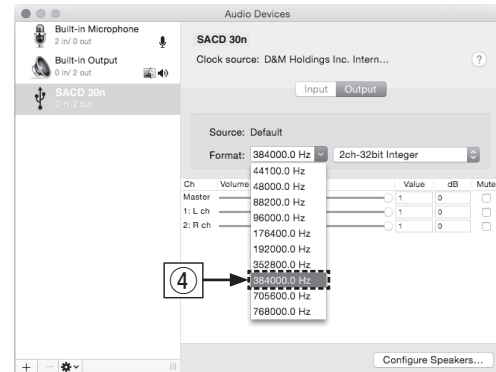

- ⑤ Quit Audio MIDI Setup.

Owner's Manual

4 Use your favorite music applications on your PC/Mac to play audio through the SACD 30n.

For high resolution audio playback you will need to obtain an advanced audio player software such as JRiver Media Center or Audirvana.

NOTE

Additional settings to output audio to the SACD 30n may have to be selected in your advanced audio player application. Please refer to the user's manual for your application.

- Refer to the Online Manual for other functions information and operation procedure details.

manuals.marantz.com/SACD30n/NA/EN/



Online Manual

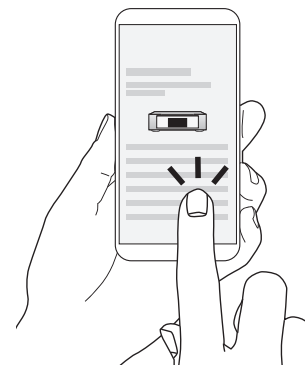

- For more information, visit **www.marantz.com**

www.marantz.com

You can find your nearest authorized distributor or dealer on our website.

marantz is a registered trademark.