



DRIJA

12 MESES de GARANTÍA
MONTHS WARRANTY

Mirror

Refrigeradores / Congeladores
Refrigerators / Freezers

INVERTER

Tecnología Eficiente
Efficient Technology

10
YEARS
WARRANTY
ON THE COMPRESSOR

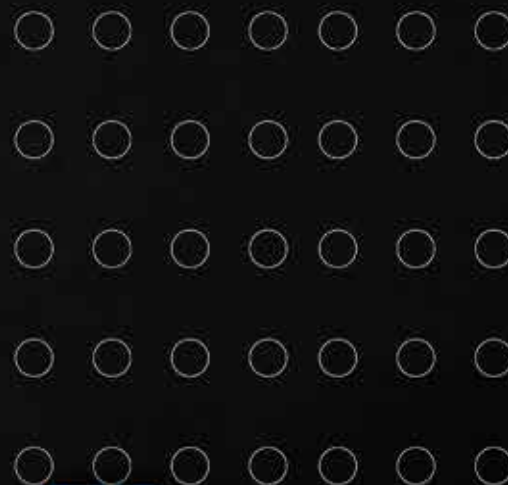

Refrigeradores / Congeladores
para Empotrar
Refrigerator / Freezer built-in

USER MANUAL

480 Liters

17 Pies Cúbicos

NOTA: Para adquirir accesorios y/o repuestos de este producto, contáctenos al call center (según el número de su país que le indique el certificado de garantía) o a nuestras redes sociales

NOTE: To purchase accessories and / or spare parts for this product, contact us at the call center (depending on the number of your country that indicates the warranty certificate) or our social networks

www.DrijaInternational.com

Para conservar la garantía de este producto, es indispensable instalarle

Protector de Voltaje

To preserve the warranty of this product, it is essential to install

Voltage Protector

User manual
FRIDGE | MIRROR



1. CAUTION.....	2
2. CHARACTERISTICS AND INSTALLATION.....	6
3. CLEANING AND MAINTENANCE.....	17

1. CAUTION

This appliance is not designed for use by persons (including children) with reduced physique, sensory or mental capabilities, or lack of experience and knowledge, unless they have been supervised or instructed in the use of the device by a responsible person. of your safety. Children must be supervised to ensure that they do not play with the appliance.

- If the power cord is damaged, it must be replaced by the manufacturer, its service agent, or similarly qualified persons to avoid a hazard.
- This device can be used by children from 8 years old and people with reduced physical, sensory or mental capacities or lack of experience and knowledge if they have received supervision or instructions on how to use the device safely and understand the dangers involved. Children must not play with the appliance.

Cleaning and user: Maintenance should not be carried out by children without supervision.

Isobutene refrigerant (R600a) is contained in the refrigerant circuit of the appliance, a natural gas with a high level of environmental compatibility, which is nevertheless flammable. During transportation and installation of the appliance, make sure that none of the components of the refrigerant circuit is damaged.

- The refrigerant (R600a) is flammable.

WARNINGS:

- Keep the ventilation openings, in the housing of the apparatus or in the built-in structure, free from obstruction.
- Do not use mechanical devices or other means to accelerate defrosting, other than those recommended by the manufacturer.
- Do not damage the refrigerant circuit.
- Do not use electrical appliances inside the appliance's food storage compartments, unless they are of the type recommended by the manufacturer.
- Do not store explosive substances such as aerosol cans with a flammable propellant in this appliance.
- This appliance is designed for use in household and similar applications, such as
 - Staff kitchen areas in stores, offices and other work environments;
 - Rural houses and by clients in hotels, motels and other residential-type environments; bed and breakfast settings

WARNINGS:

- No barrier is allowed around the appliance or in the embedded structure to ensure free ventilation.
- Never use any electrical appliance in the appliance's food chamber, except the type recommended by the manufacturer.
- Never put liquid drink or food contained in a glass container in the freezing chamber for fear that it will break.
- If it is off, the refrigerator will turn on 5 minutes later for fear of damaging the compressor.
- If any live parts, abnormal noise, odor, smoke or other abnormality are found during use, it is necessary to turn off the appliance immediately and contact the Company's after-sales service department in time.
- Never put your finger or hand under the refrigerator, especially at the back of the refrigerator; Otherwise, it may be hurt by the sharp matter.
- Children should not play or go up to the refrigerator. The operation of children must be supervised by their parents for fear of danger.
- Never put your hand between the doors to open or close the door for fear of jamming your finger. The door handle will be used to open or close the door.
- The two-star (*) frozen food compartments are suitable for storing pre-frozen food, storing or making ice cream and making ice cubes.
- The one-star (*), two-star (*) and three-star (*) compartments are not suitable for freezing fresh food.
- If the refrigeration appliance is left empty for long periods of time, turn off, defrost, clean, dry, and leave the door open to prevent mold from forming inside the appliance.

It depends on the actual situation of the product.

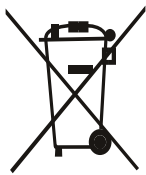

This mark indicates that this product should not be disposed of with other household waste throughout the EU. To avoid potential harm to the environment or human health from uncontrolled waste disposal, please recycle waste responsibly to promote the sustainable reuse of material resources. To return your used device, use the return and collection systems or contact the retailer where you purchased the product. They can take this product for safe recycling for the environment.

Device connection

- Alone, and the allowable voltage fluctuation range is 98V-132V
- To ensure safety, the plug and its cord must be able to withstand the current of more than 15 A
- To reduce the risk of fire, electric shock, or injury to persons when using your product, basic safety precautions should be followed, including the following.
- Read all instructions before using this appliance.

Safety information

- Using multiple devices in one outlet can cause a fire.
- Install the appliance in a dry and well-ventilated room.
- The apparatus should be placed near the outlet, it is easy to cut off the power supply at the time of the accident.
- Do not allow the plug to face upward or pinch at the rear of the refrigerator.
- Water may get inside or the plug may be damaged, resulting in fire or electric shock.
- Do not allow the power cord bent or pressed by a heavy object to be damaged. If it is damaged, it must be replaced by the service agent or a similar qualified person to avoid a hazard.
- If the power cord is damaged, it must be replaced by the manufacturer, its service agent, or similarly qualified persons to avoid a hazard.
- Do not touch food or containers in the freezer with wet hands, as it may cause frostbite.
- Do not put the heavy or dangerous object, cup, vase, cosmetics, medicine or any container with water in the refrigerator.
- It may fall and cause injury, fire or electric shock when opening or closing the door.
- Do not spray water on the outside or inside of the refrigerator or clean it with benzene or thinner.

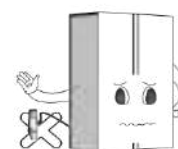

- Wait 5 minutes or more to reconnect the plug. It may cause the freezer to malfunction.
- Do not use the refrigerator for non-domestic purposes (storage of medicine or test material, blood, use on the boat, etc.). It may cause an unexpected hazard such as fire, electric shock, deterioration of stored material, or chemical reaction.
- Do not use a tumble dryer to dry the interior, or light a candle to eliminate the odor, as it may cause an explosion or fire.
- Do not hold onto the door or door trays.
- It may cause the refrigerator to fall or injure your hands. Especially do not allow children to do the above.
- When there is a gas leak, do not touch the refrigerator or the electrical outlet and ventilate the room immediately.
- Spark explosion can cause fire or burns. When a gas leak occurs due to serious damage during delivery, installation or use of the refrigerator, any spark may cause a fire or burns.
- Do not insert your hands or the metal stick into the cold air outlet, the lid, the bottom of the refrigerator, the heat-resistant grill (exhaust hole) at the rear. It can cause electric shock or injury.
- Do not put ice in a thin glass or ceramic mug. It may break the ceramic cup or tableware

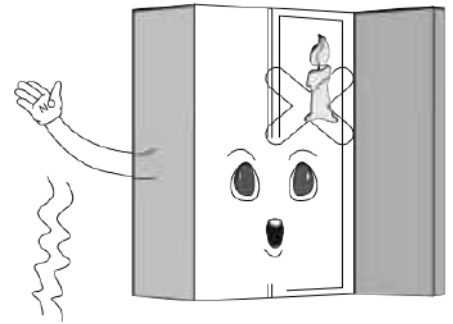

If the power cord is damaged, it must be replaced by the manufacturer, its service agent, or similarly qualified persons to avoid a hazard.

- Use the refrigerator submerged after checking. It may cause electric shock or fire.
- Do not install the refrigerator in a humid place or where it splashes water or rain.

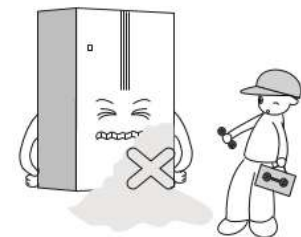

Deterioration of the insulation of electrical parts can cause electrical leakage. Check the refrigerator regularly.

- Do not install the refrigerator in a humid place or where it splashes water or rain.

- Deterioration of the insulation of electrical parts can cause electrical leakage. Check the refrigerator regularly.

2. CHARACTERISTICS E INSTALLATION

Energy saving and noise reduction.

Contains super freezing, energy saving, noise reduction, optimal cooling system to achieve.

Precise temperature control

Separate microcomputer control system to set, control and display R temperature and F temperature, more accurate control.

Automatic defrosting

Special program to reduce the temperature fluctuation of the refrigerator, it is to keep food fresh.

LED display and touch button

The control board shows respectively the temperature setting of the refrigerator and freezer chamber and the functional status; touch button operation is convenient.

Door opening alarm system

If you open the door for more than 1 minute, the alarm system will remind you to close the door.

Tempered glass, safe and reliable, easy to clean and durable.

Removable and easy to clean door seal

The door seal is easy to clean and remove, and has a long service life.

All figures in this manual are schematic; Some features and devices may not be completely consistent with your refrigerator and the specific structure and configuration will be subject to the actual product.

The appearance and specifications of the actual product may differ depending on the model.

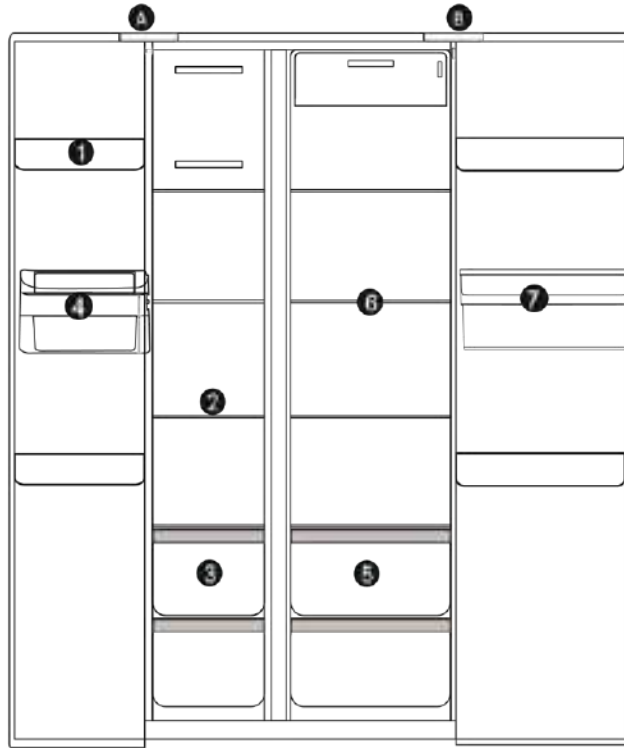

A) A freezer compartment:

1. Freezer door tray
2. Glass freezer shelves
3. Freezer drawer

B) Refrigerator compartment

4. Freezer ice machine
5. Refrigerator drawer
6. Glass refrigerator shelves
7. Refrigerator drinking machine

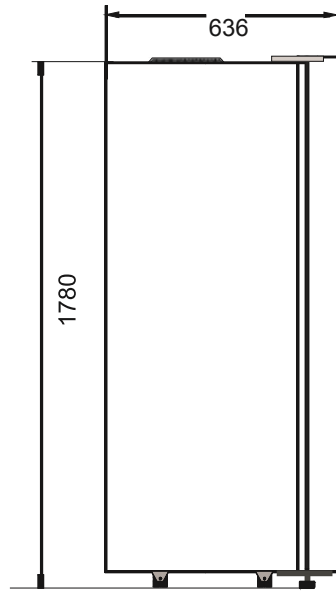
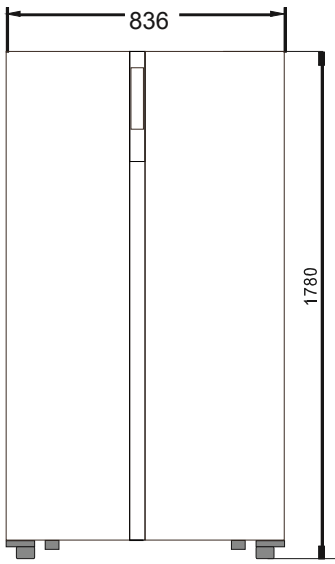

Transport



Place Environment

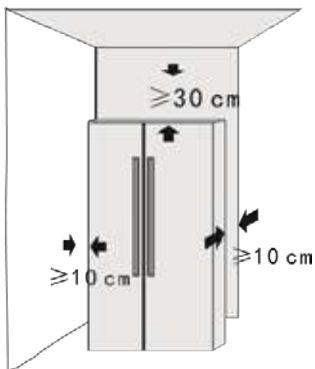

Adjust the plastic feet

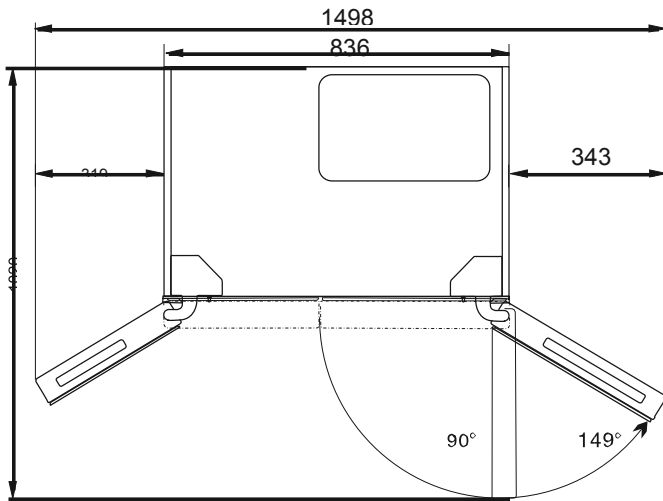

The above figure is schematic for installation only, it does not represent the actual product. The specific dimension will be subject to the product you have purchased.

To ensure adequate air circulation around the refrigerator, keep enough space. If you install the top panel or cabinet, keep enough room to move around when needed.

WARM NOTICE:

- When handling the refrigerator, at least two people are required: one lifts the upper part of the rear and the other handles the lower part (if one part is clamped, it is quite dangerous and may cause an accident).
- When moving the refrigerator, the bottom runner can damage and scratch the floor. If you need to move the refrigerator for a long distance, the internal accessories will need to be fixed with adhesive tape. Otherwise, the accessories may be damaged due to collisions with each other.

- Place the refrigerator in the position with little vibration or little exposed to vibration. For users in the area where earthquake often occurs, fix the refrigerator against the wall or pole. Otherwise, the fall of the refrigerator will cause an accident.
- Sufficient free space will be left. If the free space is too small or you place products on the top or near the side, or stick on the sides, the heat dissipation of the refrigerator will be affected, and thus cause unnecessary waste of electrical energy, as well as burn the wall. and other goods; the contact between the back and the wall will cause vibrations and noise;
- Adjust the front and the adjustment foot of the refrigerator to make it level. Failure to level the refrigerator will cause vibrations and noise.
- When moving the refrigerator, adjust the plastic feet counterclockwise to keep them off the ground, and then gently push the refrigerator into position.

LED display function setting

- The default mode is power save at startup: screen displays for 20 seconds then turns off.
- This mode to save energy and extend the life of the LED lights.

Operation keys

Display panel diagram and operation

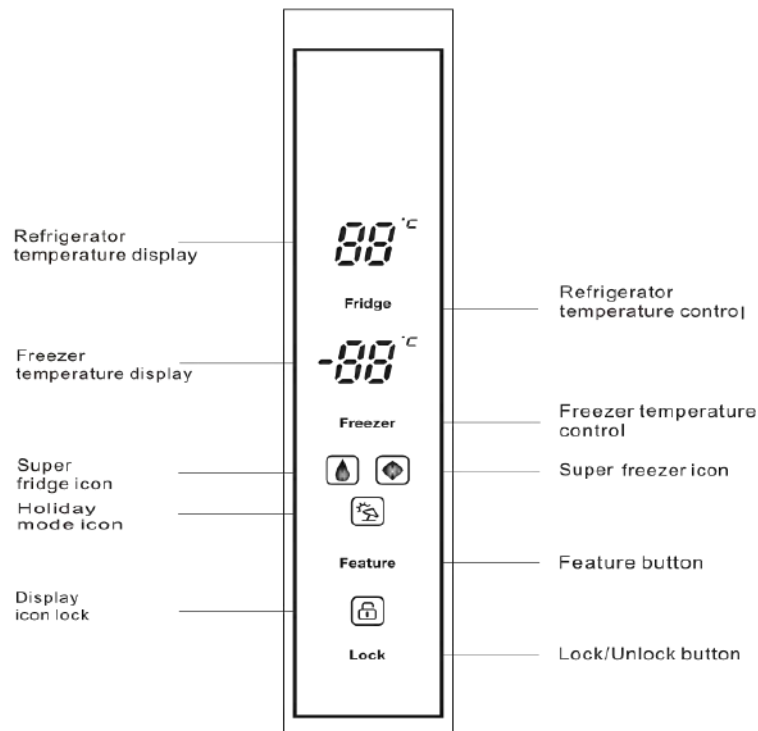

Before Using

Remove all packages, including the foam backing at the bottom of refrigerator and the tapes fixing accessories in the box.

Place the refrigerator to a proper position, and adjust the feet to level. It is better to clean the refrigerator before use.

Remove the film: There is a layer of transparent film on the panel of our product, which can protect products from being scratched in the process of production and transportation, and you can choose to reserve or remove the film as needed.

Place the refrigerator and adjust to level, clean it, let the refrigerator stand for above 2 ~ 6 hours, and then power on to ensure that the refrigerator can operate normally.

Function setting of LED display

The default mode is energy saving upon startup: The screen displays for 20 s and then goes off.

This mode to save energy and prolong the service life of LED lights.

Feature selection

Each press of the "Function" button will cycle through the operating modes.

- ***Holiday mode:*** the refrigerator will run at 6 ° C while the freezer will run at -15 ° C.
- ***Super freezer mode:*** when super freezer mode is selected, the compressor will run continuously to freeze food faster and keep food fresh
- ***Super freezer mode:*** it will turn off automatically after 24 hours of operation or when the freezer reaches -28 °. C. The super freezer icon will turn off and the freezer will continue to operate at the normal set temperature.
- ***Super fridge mode:*** when super fridge mode is selected, the fridge compartment reaches the set temperature in the shortest time possible to keep the food as fresh as possible. In this mode, the programmed temperature of the refrigerator compartment is locked at 0 ° C. The program lasts 150 minutes maximum and then exits automatically, the super refrigerator icon turns off, indicating that the super refrigerator function is disabled, the set temperature returns to last before super cooler mode operates.

Freezer behavior setting

- The default freezer temperature is -18 ° C. To change the temperature, press the "Freezer" button to cycle through the set temperatures.

Temperature, press the "Refrigerator" button to cycle through the set temperatures.

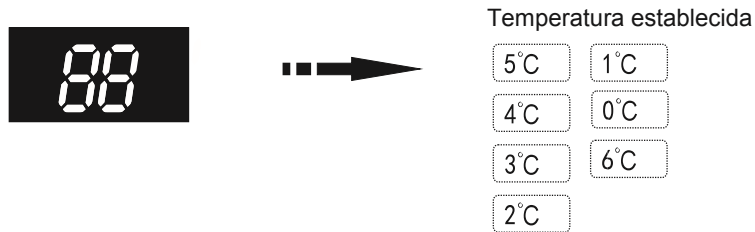

Lock Button

- This product has a button lock function.
- Press the "Lock" button to enable lock mode and the lock icon will be visible.
- While the refrigerator is in this mode, the other buttons on the control panel will not work, when the buttons are touched, a chime will sound and the lock icon will flash.
- To exit lock mode, press and hold the lock button for 3 seconds until the icon is no longer displayed.



Door Alarm

- When the refrigerator door is open for more than 1 minute, the buzzer will sound to remind users to close the door. After the door is closed, the alarm sound will stop automatically

Chamber refrigerator

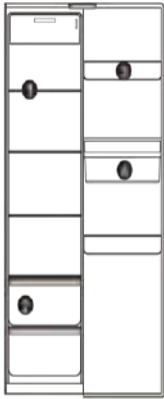

- The cold room is mainly used to store food that is kept for a short time.

- The refrigerator compartment is suitable for storing fruits, vegetables, drinks and other foods that will be eaten recently. It is suggested to seal the food and then put it in the refrigerator.

- Suggested sections of the refrigerator chamber for various foods

1. Glass shelf: wheat food, milk, etc ...

2. Drawer: fruits, vegetables, etc ...

3. Upper tray: dairy products, fragrant foods, etc ...

4. Drinking machine: can store water and drink directly (only direct drinking water or mineral water can be stored in the water tank).

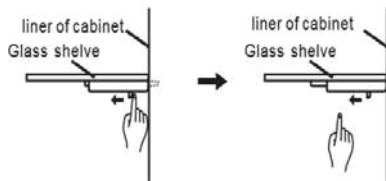

Fruit and Vegetable Box

- The refrigeration chamber has a fruit and vegetable box, which can retain the moisture of the fruits and vegetables and keep the proper box humidity. It is suitable for storing fruits and vegetables.

- Glass shelves When removing the glass shelf, press the movable pin under the shelf with both hands and push in at the same time. Then the glass shelf will be removed

Cámara de congelación

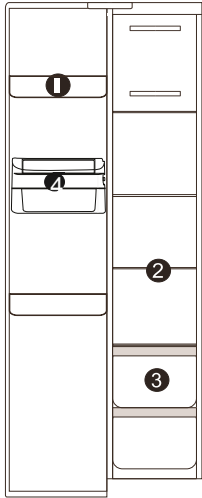

- The freezing chamber is used to freeze food, store deep frozen food and make ice cubes. It can preserve food for a long time.

- The freezing chamber is suitable for keeping food fresh for a long time. When storing meat, it is suggested to cut the meat into pieces that are easy to remove and mark the freezing date to prevent the food from exceeding the time limit.

- Suggested freezer chamber sections for various foods and variety
- Upper bottle rack: small frozen items;
- Glass shelf: frozen foods, such as fish, meat and ice cream;
- Drawer: packaged frozen food, etc ...
- Freezer Ice Maker - Make ice.

Freezer Chamber Drawer

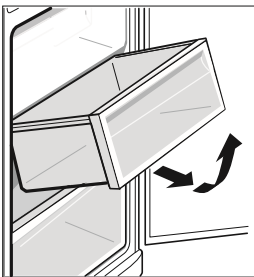

The upper drawer of the freezing chamber can freeze and store large volume food, and the lower drawer is mainly used for storing frozen food.

Food, especially oily food that was stored in the refrigerator, avoid direct contact with the coating.

CAUTION: Oil or oily food soup stains should be cleaned immediately to avoid prolonged contact with the coating which can lead to

corrosion and cracking of the coating.

Instructions for storing food

- When storing frozen food, place it inside the freezer room, other than the bottle rack.
- Do not put packaged or canned food in the freezer room.
- Before putting hot food in the refrigerator, first cool it to room temperature; otherwise, they will increase power consumption.



- Divide foods into suitable pieces and pack them separately, which are easy to freeze completely and will not freeze together.
- Packaging materials must be odorless, airtight, watertight and free from contamination, so that packaged foods are not easily contaminated with other odors.
- Do not put too many fresh food in the freezing chamber once, preferably without exceeding the value of the refrigerator's freezing capacity. Melted foods cannot be refrozen, unless they are turned into plates; otherwise, the quality of your service will suffer.
- Glass bottles or containers should not be placed in the freezing chamber or in the air outlet of the cooling chamber duct; Otherwise, the food cannot block the air outlet; otherwise, abnormal air circulation

Tips to save energy

- Be sure to keep the refrigerator away from sources of heat and water
- Before storing hot food, cool it to room temperature and then
- Closing
- the door on time, reduce the opening frequency and shorten
- When defrosting frozen food, you can put it in the cold room, which will help to cool the food.
- Make sure the temperature sensor is not covered or blocked by food and keep a proper distance from food.

3. CLEANING AND MAINTENANCE

Before cleaning or performing maintenance on the gas hob, disconnect it from the power source.

To prolong the life of the refrigerator, it is absolutely essential that it be cleaned carefully, thoroughly and, in general, take into account the following:

- The enameled parts and the external part should be washed with warm water without using abrasive powders or corrosive substances that can ruin them;
- Glass doors should be cleaned with glass or alcohol, with a new cloth.
- The other steel parts can be stained if contact is maintained with high-concentration calcareous water or corrosive detergents (containing phosphorus). To prolong the shelf life, we recommend that these parts be thoroughly rinsed with water and dried by blowing. It is also a good idea to clean up any spillage.
- After the refrigerator is being used, the exterior should be cleaned with a damp cloth to remove dust or food debris.
- It is suggested to keep the refrigerator once a month;
- Unplug the power cord to avoid electric shock;
- Use a damp cloth or neutral detergent (cleaning essence) to clean
- Contamination by oil and other dirt. Then thoroughly clean the detergent.
- Do not use alkaline detergents, powdered soap, gasoline and alcohol, talcum powder, etc .; otherwise, coats or plastics may be damaged
- Regularly clean the body of the refrigerator and clean the dust from the floor to keep the refrigerator clean.

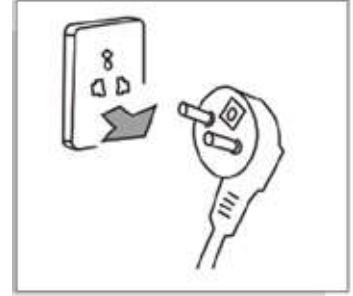

Inspections after maintenance:

1. If there is damage to the power line and plug;
2. If there is dust on the power plug;
3. If there is abnormal heat in the plug;
4. If the socket is loose;
5. If the plug is fully inserted.

Note: If the power line and plug are damaged and there are dusts, electric shock or fire may occur; After disconnecting the plug, it must take 5 minutes before plugging it back in; Do not put your hands under the refrigerator to avoid hurting yourself.

Defrosting

This equipment has automatic defrosting function, without manual operation.

Cleaning

Precautions for internal and external cleaning of the refrigerator:

- Before cleaning, always turn off the power switch, disconnect the power plug.
- During cleaning, make sure that no water gets on the switch, control panel, door light, and upper control box.
- Remove dirt from the outside of the refrigerator with a mild cleaner, then wipe with a clean, soft cloth and allow the refrigerator to dry naturally.
- When cleaning the door sealing strip, always use clean water, wipe it with a dry cloth and allow it to dry naturally. Dampen a soft cloth with lukewarm water or a neutral cleaner to clean the body of the refrigerator, except for the door sealing strip.
- It is forbidden to rinse the refrigerator directly with water, which will affect the electrical insulation properties, etc.
- It is forbidden to clean the refrigerator with metal cloths, utensil brushes, coarse abrasive cleaners, strong alkaline detergents, or flammable or toxic cleaning fluids.

After cleaning, connect the power plug of the refrigerator and connect it with the refrigerator.

Vacation

- When you want to go on vacation, it is best to run the refrigerator continuously and leave food that can be stored for a short time. If you want to stop the refrigerator, remove all food, unplug the power plug, thoroughly clean the inside of the refrigerator, and open the door to avoid abnormal odors.

In power outage

- Generally, a short-term power failure will not affect the refrigerator temperature in an abrupt way. However, if the power outage lasts for a long time, it will reduce the frequency of opening the refrigerator and not put fresh food in the refrigerator (prevent the increase in the temperature of the refrigerator from being accelerated).
- If you know that a power outage is coming, you can activate the "Super Freezer" function in advance to keep the refrigerator temperature at the lowest setting.

Shut down

- Generally, it is not suggested to stop the refrigerator or turn off the ignition switch; otherwise, the life of the refrigerator may be affected.

Maintenance

Button failure

Check the control board if the refrigerator is in lockout mode. When in lock mode, all buttons cannot work.

Low voltage, the compressor cannot start.

You should buy more than 1000W pressurizer when the appliance installation area, it is better to protect your refrigerator.

Long time to start

When the ambient temperature is too high, it will take a long time to turn on the appliance.

Middle rafters feel hot

The middle beams feel hot after a period of time of operation of the appliance, belongs to the normal phenomenon.

Dew drops

When outside air flows to the cold inside surface of the refrigerator, dew drops can form.

If the humidity at the installation site is high or during the rainy season, dew drops may form on the outside of the refrigerator. This is a natural phenomenon that occurs during wet weather, please wipe the water droplets with a dry cloth.

Noise

When you operate the refrigerator for the first time, the refrigerator will run at high speed to cool down quickly and the sound may seem louder. When the internal temperature drops below a certain level, the noise will decrease.

When the compressor operation is starting or ending; various parts expanding / contracting or various control devices operating or changing the temperature inside the refrigerator, you will hear the sounds, these are normal sounds.

Hot compressor

When it is working, the outside temperature of the compressor is higher than 80 °C, do not touch the compressor, it may cause serious injury.

Long life compressor

When the room temperature is too high or too much fresh food is placed in the refrigerator, it will take a long time to cool down until the appliance operates at the set temperature.

User manual
FRIDGE | MIRROR



Fault	Possible Cause	Remedial Action
No display on the display panel	The mains plug of the appliance is not in the socket properly. The fuse for the domestic supply is switched off	Check whether the power is on: the fuse must be switched on
Alarm Sound	Door is slightly open or not close more than 1 minute	Close the door completely
The compressor do not work	<ul style="list-style-type: none"> • It's under defrosting mode • Power is not connected well 	It's normal for defrosting: Check whether the power is connected well
Compressor runs too long	<ul style="list-style-type: none"> • The fridge has recently been disconnected for a period of time • Put too much fresh or hot food • Doors are opened too frequently or too long 	<ul style="list-style-type: none"> • It takes some hours for the fridge to cool down completely • Hot food will cause the fridge to run longer until the desired temperature is reached • Warm air entering the fridge cause it to run longer. Open the door less often.
Vibrating noise	<ul style="list-style-type: none"> • Floor is uneven or weak • Items placed on the top of the fridge are vibrating • Fridge is touching wall or cabinets 	<ul style="list-style-type: none"> • Be sure floor is level and solid and can adequately support fridge • Remove items • Move fridge so that does not touch the wall or cabinets