



# DRIJA

2 YEARS WARRANTY

## Quadrato 90

Extractor de Grasa  
Range Hood



Incluye 2 Filtros de Carbón Activo  
Includes 2 Active Carbon Filters



TUTORIALS OF  
TECHNICAL SUPPORT

## USER MANUAL

110V / 60Hz

NOTA: Para adquirir accesorios y/o repuestos de este producto, contáctenos al call center (según el número de su país que le indique el certificado de garantía) o a nuestras redes sociales

NOTE: To purchase accessories and / or spare parts for this product, contact us at the call center (depending on the number of your country that indicates the warranty certificate) or our social networks

 [www.DrijaInternational.com](http://www.DrijaInternational.com)

! Para conservar la garantía de este producto, es indispensable instalarlo a no menos de **30"=75 cm** de la estufa

To preserve the warranty of this product, it is essential to install it at not less than **30"= 75 cm** from the stove.

# CONTENT

Safety Warning.....	2
Notice.....	4
Feature.....	4
Installation.....	5
Use.....	6
Notice of installation.....	7
Maintenance.....	8
Abnormity and Solution.....	9
Warranty card.....	10
Environmental Protection.....	11

## Safety Warning

- Never let the children operate the machine.
- The cooker hood is for home use only, not suitable for barbecue, roast shop and other commercial purpose.
- The cooker hood and its filter should be clean regularly in order to keep in good working condition.
- Clean the cooker hood according to the instruction manual and keep the unit from danger of burning. If the supply cord is damaged, it must be replaced by the manufacturer, its service agent or similarly qualified persons in order to avoid a hazard(see 9 part)
- Forbid the direct baking from the gas cooker.
- Please keep the kitchen from a good convection.
- Before connecting this appliance check that the power supply cord is not damaged. A damaged supply cord must be replaced by qualified service personnel only. There is fire risk if cleaning is not carried out in accordance with the instructions.
- There shall be adequate ventilation of the room when the range hood is used at the same time as appliances burning gas or other fuels.
- The air must not be discharged into a flue that is used for exhausting fumes from appliances burning gas or other fuels.
- Regulations concerning the discharge of air have to be fulfilled.
- This appliance is not intended for use by persons(including children)with reduced physical, sensory or mental capabilities, or lack of experience and knowledge, unless they have been given supervision or instruction concerning use of the appliance by a person responsible for their safety.
- Children should be supervised to ensure that they do not play with the appliance.
- Do not flambé under the range hood.
- The range hood is not intended to be installed over a hob having more than four hob elements.
- This appliance is not intended for use by persons(including children)with reduced physical, sensory or mental capabilities, or lack of experience and knowledge, unless they have been given supervision or instruction concerning use of the appliance by a person responsible for their safety.
- Children should be supervised to ensure that they do not play with the appliance.
- The air must not be discharged into a flue that is used for exhausting fumes from appliances burning gas or other fuels.
- When the range hood and appliances supplied with energy other than electricity are simultaneously in operation, the negative pressure in the room must not exceed 4 Pa(4x 10<sup>-5</sup> bar)
- CAUTION: Accessible parts may become hot when used with cooking appliance.

## Safety Warning

- The light source contained in this luminaire shall only be replaced by the manufacturer or his service agent or a similar qualified person.
- If the external flexible cable or cord of this luminaire is damaged, it shall be exclusively replaced by the manufacturer or his service agent or a similar qualified person in order to avoid a hazard.

### Electrical Shock Hazard

- Only plug this unit into a properly earthed outlet. If in doubt seek advice from a suitably qualified engineer.
- Failure to follow these instructions can result in death, fire, or electrical shock.
- The instructions shall state the substance of the following:
  - there shall be adequate ventilation of the room when the range hood is used at the same time as appliances burning gas or other fuels (not applicable to appliances that only discharge the air back into the room);
  - the details concerning the method and frequency of cleaning;
  - there is fire risk if cleaning is not carried out in accordance with the instruction;
  - CAUTION: Accessible parts may become hot when used with cooking appliances;
  - The air must not be discharged into a flue that is used for exhausting fumes from appliances burning gas or other fuels (not applicable to appliances that only discharge the air back into the room);
  - the minimum distance between the supporting surface for the cooking vessels on the hob and the lowest part of the range hood. (When the range vessels on the hob and the lowest part of the range hood. (When the range hood is located above a gas appliance, this distance shall be at least 65 cm.
  - regulations concerning the discharge of air have to be fulfilled.
- The installation instructions for range hoods with accessible metallic enclosures of class II construction shall include details that indicate the location and maximum permitted lengths for any fixing or mounting screw or other fixing device that penetrates into the range hood to attach an accessory such as a fascia or duct fitting.



## NOTICE

1. Thank you for choosing our cooker hood. Please read the instruction manual carefully before use.
2. The installation work must be undertaken by a qualified and competent fitter.
3. The manufacturer disclaims all liability for any damage or injury caused as a result of not following instructions for installation contained in the following text.

The range hood is used on 110V / 60Hz

## FEATURE

1. The cooker hood uses high quality materials, and is made with a streamlined design.
2. Equipped with a large power low noise electric motor and centrifugal leaf, it produces strong suction, low noise, non stick grease filter and easy to clean.
3. With the isolated low voltage circuit board control, 12V DC input, the lights are therefore safer.
4. Special wind tunnel construction and oil collector design, free dirt will be absorbed in a second.

## Installation

### Product three( island):

1. Make sure of installation position, fix the hanging scaffold at proper position, and check firmness and smoothness of installation. See the pic 1.
2. Adjst to proper height, joint the bracket, install on hanging scaffold. See the pic 2.
3. Fix inside chimney on hanging scaffold, enclose outside chimney on it at proper position, insert hook into bracket to fix outside chimney temporarily. See the pic 3.
4. Fix air outlet in the vent on hood's body, connect extensible pipe with air outlet. See the pic 4.
5. Extend the hose out off hanging scaffold, fix hood's body on bracket. See the pic5.
6. Detach the hook, move outside chimney downward till reaching hood's body. Pay attention not to strike the glass. See the pic 6.

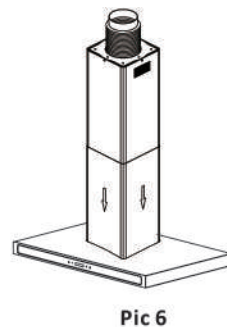
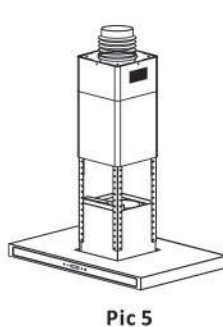
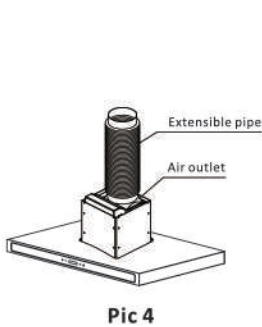
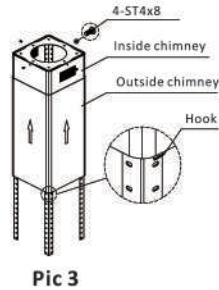
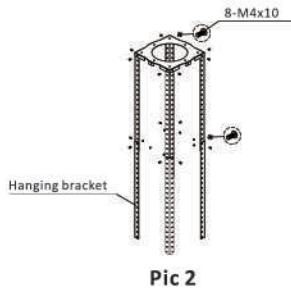
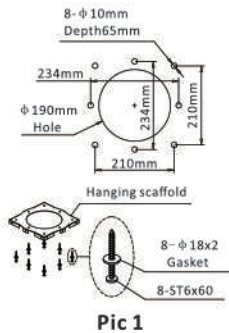

## USE(Speed adjustment)

### Touch control switch:

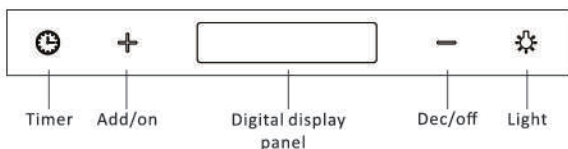

1. 🕒 Timer, which can set from one minute to 60minutes
2. ⚙️ Light on/off
3. ⊕ Speed adding from low to middle, and to high by sequence.
4. ⊖ Speed descending by sequence from high to middle, and to low until the power stops running.

### Touch Switch:

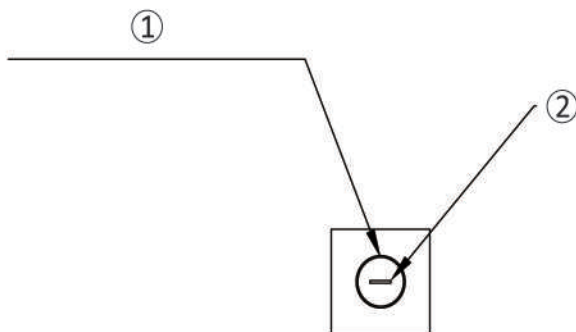

- ① Illumination changing from Red/Yellow/Blue Based on speeds adjustment.
- ② White color illumination constantly while operating.

### Functions:

1. press the button for two seconds, the motor starts operating at low speed and the lighting is on;
2. press the button softly again, it switches to medium speed and the lighting is on;

3. press once again, it switches to high speed and the lighting is on;
4. if pressing again, it will switch to the low speed and go cycles like above
5. any condition of operating, press two seconds, it will be power-off.

## NOTICE OF INSTALLATION

1. Before installation, please ensure the area is clean to avoid suction of the remaining bits of broken wood and dust.
2. It cannot share the same air ventilation tube with other appliance such as gas tube, warmer tube, and hot wind tube.
3. The bending of ventilation tube should be  $\geq 120^\circ$ , parallel or above the start point and should be connected to the external wall.
4. After installation, make sure that the extractor is level to avoid grease collection at one end.

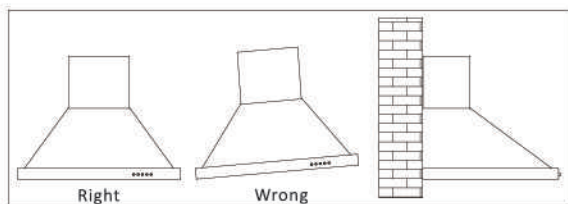



## MAINTENANCE

### 1.The cleaning of the carbon grease filter mesh

The filter mesh is made of high-density stainless steel. Please do not use the corrosive detergent on it. Keeping this filter clean will keep the appliance running correctly. Please strictly follow the guidelines below.

Method 1: Put the mesh into 40-50 c clean water, pour on detergent, and soak for 2-3 mins. Wear gloves and clean with a soft brush. Please do not apply too much pressure, as the mesh is delicate and will damage easy.

Method 2: If instructed to do so, it can be put into a dishwasher, set the temperature at around 60 degrees.

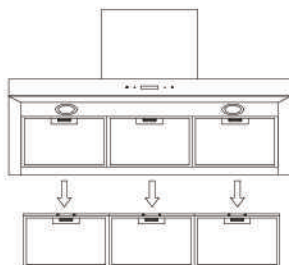

### 2.Notice of cleaning cooker hood

A.To protect the main body from corrosion over a long period of time, the cooker hood should be cleaned with hot water plus non corrosive detergent every two months.

B.Please do not use abrasive detergent or deodorant for it will damage the body.

C.Keep the motor and other parts free from water, as this will cause damage to the appliance.

D.Before cleaning the appliance please remember to cut off power.

E.The carbon filter shouldn't be exposed to heat.

F.Please don't tear open the fixed bar around the carbon filter.

G.If the plug or cord is damaged, please replace it with special soft cord.

H. Cleaning and maintenance is not carried out by children without supervision.

## Abnormity and Solution

Fault	Cause	Solution
Light on, but motor does not work	The leaf blocked	Get rid of the blocking
	The capacitor damaged	Replace capacitor
	The motor jammed bearing damaged	Replace motor
	The internal with of motor off or a bad smell from the motor	Replace motor
Light does not work, motor does not work	Beside the above mentioned, check the following:	
	Light damaged	Replace lights
	Power cord looses	Connect the wires as per the electric diagram
Oil leakage	One way valve and the air ventilation entrance are not tightly sealed	Take down the one way valve and seal with glue
	Leakage from the connection of U-shaped section and cover	Take U-shaped section down and seal with soap or pain
Shake of the body	The leaf damaged and causes shaking	Replace the leaf
	The motor is not tightly hanged	Lock the motor tightly
	The body is not tightly hanged	Fixed the body tightly
Insufficient suction	The body is not tightly hanged	Readjust the distance
	Too much ventilation from open doors or windows	Choose a new place and resemble the machine
The machine inclines	The fixing screw not tight enough	Tighten the hanging screw and make it horizontal
	The hanging screw not tight enough	Tighten the hanging screw and make it horizonta

## Warranty Card

We will warrant this product free from defects in material and quality for one year from date of purchase. If any problems occur from correct usage, please contact the service department for under warranty service.

This warranty does not cover the following:

The filter mesh and bulb.

Commercial use.

Amendment of the date of manufacture on the rating plate.

After 12 months from date of purchase.

Damaged caused to the body by usage of detergent sprayer.

Pollution made to the led parts, glass parts and S/S parts.

Incorrect installation, misuse, abuse or neglect.

Incorrectly fitted to insufficient or unsuitable power.

Damage caused by foreign object.

Taken apart or serviced by unauthorized service engineers or replaced with other manufacture's components.

For commercial use the maintenance and free service should be discussed with our authorized agent.

Beyond the 12 month warranty period, the purchaser should pay for charge of components and call out.

In the event of a service call, please provide the warranty card and receipt of date of purchase.

Place of  
purchase \_\_\_\_\_

Date of  
purchase \_\_\_\_\_

Model \_\_\_\_\_

Shop  
stamp \_\_\_\_\_

## ENVIRONMENTAL PROTECTION

Waste electrical products should not be disposed of with household waste.  
Please recycle where facilities exist. Check with your Local Authority or retailer for recycling advice.



User Manual  
RANGE HOOD | QUADRATO 90

**DRIJA**

# DRIJA

## Quadrato 90

Extractor de Grasa / Range Hood

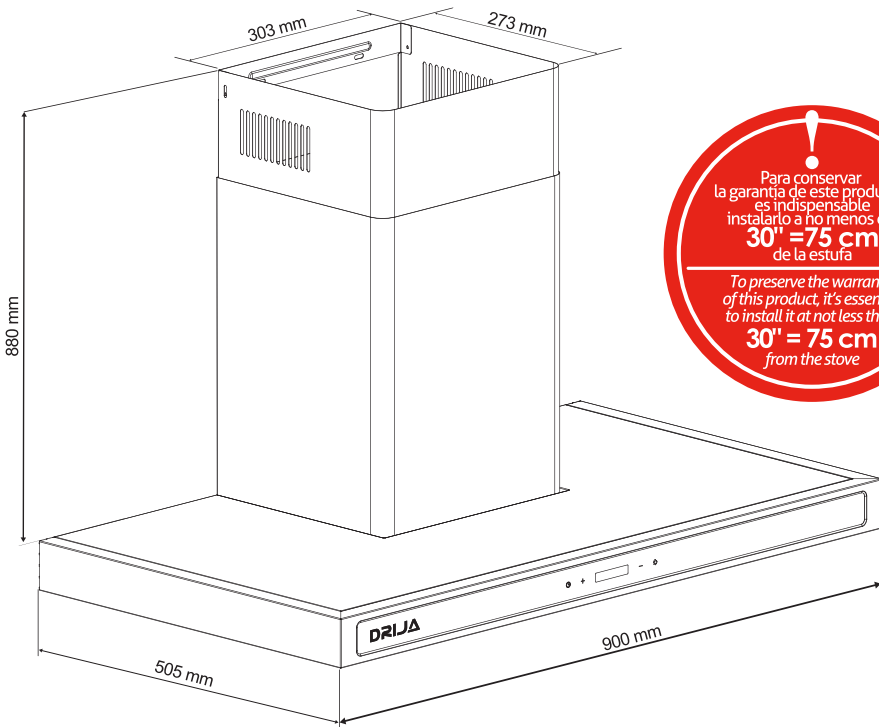

Para conservar la garantía de este producto, es indispensable instalarlo a no menos de **30" = 75 cm** de la estufa

To preserve the warranty of this product, it's essential to install it at not less than **30" = 75 cm** from the stove