

2 YEARS WARRANTY



DRIJA

Alemania 90

ELECTRIC PROFESSIONALE

Estufa Eléctrica para Empotrar
Electric Stove Built-In

Ceika
Quemadores
Hot Plate

10 YEARS WARRANTY IN VITRO SCHOTT CERAN®

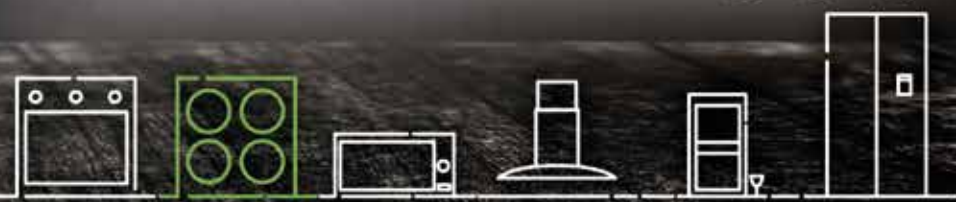
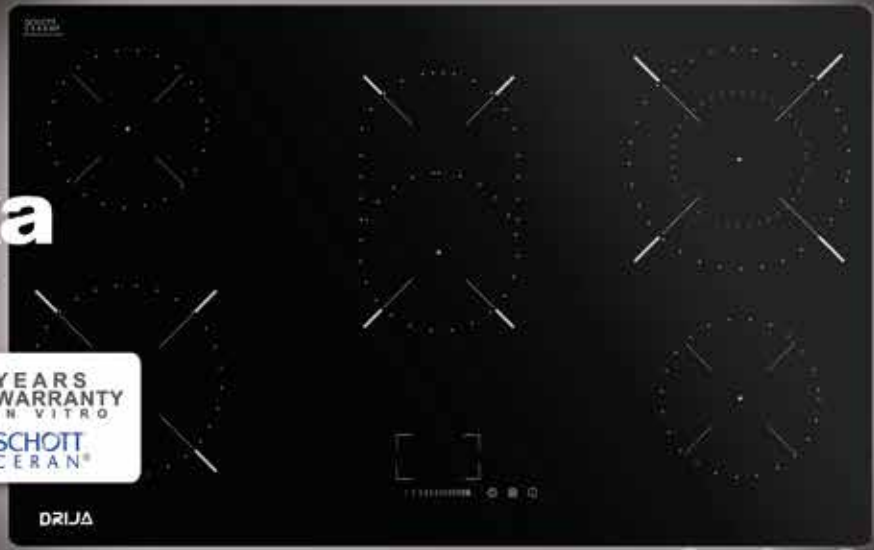

Estufa Eléctrica para Empotrar
Electric Stove Built-In



TUTORIALS OF TECHNICAL SUPPORT

USER MANUAL

220-240V / 50-60Hz

NOTA: Para adquirir accesorios y/o repuestos de este producto, contáctenos al call center (según el número de su país que le indique el certificado de garantía) o a nuestras redes sociales

NOTE: To purchase accessories and / or spare parts for this product, contact us at the call center (depending on the number of your country that indicates the warranty certificate) or our social networks

www.DrijaInternational.com

User Manual
ELECTRIC STOVE BUILT-IN | ALEMANIA 90 PROFESSIONALE



1. INTRODUCTION	2
2. OPERATION AND MAINTENANCE	3
3. PRODUCT INTRODUCTION	6
4. CONTROL PANEL	6
5. TECHNICAL SPECIFICATIONS	7
6. PRODUCT OPERATION	8
7. HOW TO USE	9
8. KITCHEN GUIDE	16
9. CUIDADO Y LIMPIEZA	18
10. INSTALLATION	20

1. INTRODUCTION

SAFETY WARNINGS

Your security is important for us. Read this information before using your stove.

ELECTRIC SHOCK HAZARD

Disconnect the stove from the mains before performing any work or maintenance.

Connecting to a good grounding system is essential and mandatory.

Alterations to the home wiring system should only be done by a qualified electrician.

Failure to do so may result in electric shock or death.

CUTTING HAZARD

Be careful - the edges of the panel are sharp. Failure to take precautions could result in injury or cuts.

IMPORTANT SAFETY INSTRUCTIONS

Read these instructions carefully before installing or using this range.

No combustible materials or products should be placed on this stove at any time.

Please make this information available to the person responsible for installing the stove as it may reduce installation costs.

To avoid danger, this stove must be installed in accordance with these installation instructions.

This stove must be installed and grounded by a properly qualified person.

This stove must be connected to a circuit that incorporates an isolation switch that provides a complete disconnection of the power supply.

Failure to install the stove correctly can invalidate any warranty claim or liability.

2. OPERATION AND MAINTENANCE

ELECTRIC SHOCK HAZARD

Do not cook in a broken or cracked stove. If the stove surface should crack or crack, immediately switch off the stove to the mains (wall switch) and contact a qualified technician.

Turn off the heater on the wall before cleaning or maintaining it.

Failure to do so may result in electric shock or death.

HEALTH HAZARD

This appliance complies with electromagnetic safety standards. However, people with pacemakers or other electrical implants (such as insulin pumps) should consult with their health care provider or manufacturer of implants before using this stove to make sure that their implants will not be affected by the electromagnetic field. Failure to follow this advice may result in death.

HOT SURFACE HAZARD

During use, accessible parts of this stove will be heated sufficiently to cause burns.

Do not let your body, clothing or any item other than contact suitable containers the ceramic glass until the surface is cool.

Metal objects such as knives, forks, spoons and lids should not be placed on the surface of the hob as they may become hot.

Keep children away.

The handles of the pans may be hot to the touch. Check Pan Handles do not come out of other cooking zones that are on. Keep handles out of the reach of children.

Failure to follow this advice could result in burns and scalds.

CUTTING HAZARD

The sharp blade of a scraper for stoves is exposed when the safety cover is removed. Use with extreme caution and always keep it out of reach of children.

Failure to take precautions could result in injury or cuts.

IMPORTANT SAFETY INSTRUCTIONS

Never leave the oven unattended when in use. Boiling causes smoke and greasy spills that can ignite.

Never use your stove as a work surface or storage area.

Never leave objects or utensils on the stove.

Do not place or leave magnetizable objects (eg, credit cards, memory cards) or electronic devices (eg computers, MP3 players) near the stove as they may be affected by their electromagnetic field.

Never use your stove to heat or heat the room.

After use, always turn off the cooking zones and the hob as described in this manual (ie using the touch controls). Do not rely on the pan detection function to turn off the cooking zones when you remove the pans.

Do not allow children to play with the appliance or to sit, stand or climb on it.

Do not store items of interest to children in the cabinets above the stove. Children climbing the kitchen surface could be seriously injured.

Do not leave children alone or unattended in the area where the range is in use.

Children or persons with a disability that limits their ability to use the stove must have a responsible and competent person to instruct them in their use. The instructor must be convinced that he can safely use the stove for himself or his environment.

Do not repair or replace any part of the cook top unless specifically recommended in the manual. All other services must be performed by a qualified technician.

Do not use a steam cleaner to clean the stove.

Do not place or drop heavy objects on the cooking surface.

Do not stand on the stove.

Do not use containers with jagged edges or skimmers through the ceramic glass surface as this may scratch the glass.

Do not use scouring pads or other abrasive cleaning agents to clean the cooking surface as they may scratch the glass ceramic.

If the power cord is damaged, it must be replaced by the manufacturer, its service agent or qualified persons to avoid risk.

This stove is intended for use in domestic and similar applications, such as: - kitchen areas in workshops, offices and other working environments; - Country houses; - by customers in hotels, motels and residential environments; - rooms type bed and breakfast.

WARNING: The stove and its accessible parts are heated during use.

Care must be taken not to touch the heating elements.

Children under 8 years of age will be kept away unless they are continuously supervised.

This stove can be used by children 8 years of age or older and people with physical, sensory or mental problems or lack of experience and knowledge if they have been given supervision or instructions on using the stove in a safe manner and understand the hazards involved.

Children should not play with the stove. Cleaning and maintenance of the user will not be done by unsupervised children.

WARNING: Unattended cooking on a cook top with grease or oil can be dangerous and can cause a fire. NEVER attempt to extinguish fire with water, but turn off stove. And then cover the flame, for example, with a fire cover or blanket.

WARNING: Fire hazard: Do not store objects on cooking surfaces.

Warning: If the surface is cracked, turn off the stove to avoid the possibility of electric shock, for glass ceramic surfaces or similar material that protect the active parts

Do not use a steam cleaner.

The range is not designed to work with an external timer or a separate remote control system.

CONGRATULATIONS FOR THE PURCHASE OF YOUR NEW VITROCERAMIC.

We recommend that you take some time to read this instruction / installation manual to fully understand how to properly install and use it. For installation, read the installation section.

Read all safety instructions carefully before use and retain this instruction / installation manual for future reference.

3. PRODUCT INTRODUCTION

TOP VIEW

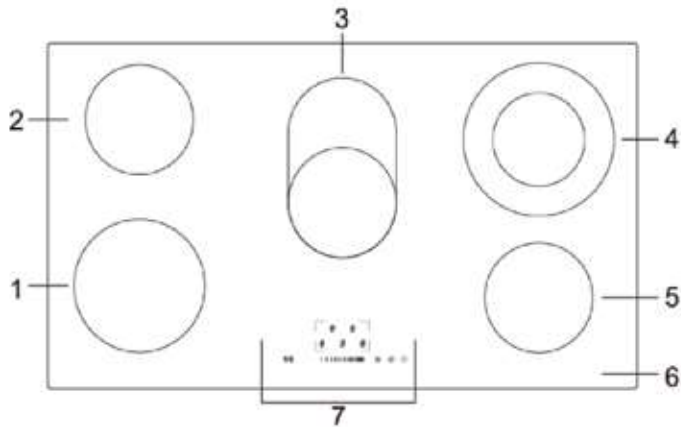

- 1. Max. 1000 / 2000W
- 2. Max. 1000 / 2200W
- 3. METRO ax. 1800 W
- 4. METRO ax. 1200 W
- 5. Glass plate
- 6. ON / OFF
- 7. Control Panel.

4. CONTROL PANEL

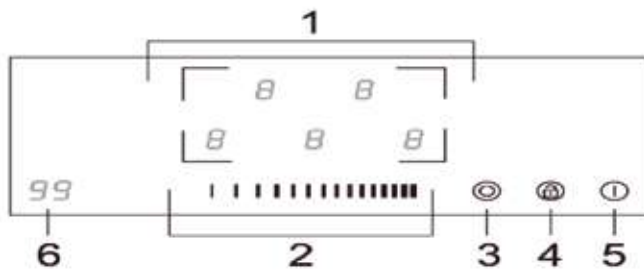

- 1. Power Controls
- 2. Timer control
- 3. Dual Zone Controls
- 4. Keyboard lock
- 5. ON / OFF control.

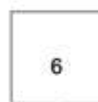

PRODUCT INFORMATION

The micro-ceramic hob can satisfy different types of kitchen demands due to resistance wire heating, micro-computerized control and multi-power selection, really the optimal choice for modern families.

The glass ceramic is customer focused and adopts a custom design. The worktop has safe and reliable functions, making your life comfortable and allowing you to fully enjoy the pleasure of life.

OPERATING PRINCIPLE

This ceramic kitchen top uses wire resistance heating directly, and adjust the power output by power regulation with the touch controls.

BEFORE USING YOUR NEW VITROCERAMIC

Read this guide, taking special note of the 'Safety Notices' section.

Remove any protective film that may still be on your glass ceramic hob.

5. TECHNICAL SPECIFICATIONS

Model	ALEMANIA 90
Cooking zones	5 Zones
Voltage supply	220-240V~ 50/60Hz
Installed Electric Power	400V 3N ~ 50 / 60Hz 7200W
Measurements of the device L × W × H (mm)	900X520X55
Construction Dimensions A × B (mm)	875X495

Weight and dimensions are approximate. Because we continually strive to improve our products we can change specifications and designs without prior notice.

6. PRODUCT OPERATION

TACTILE CONTROLS

The controls respond to the touch, so there is no need to apply any pressure. Use the ball of your finger, not your tip.



You will hear a beep every time a tone is recorded.

Make sure that the controls are always clean, dry, and that no objects (eg, utensil or cloth) are covering them. Even a thin layer of water can hinder the operation of controls.

CHOOSING THE CORRECT UTENSILS

Do not use kitchen utensils with jagged edges or a curved base.



Make sure the base of your pan is soft; it sits flat against the glass and is the same size as the cooking zone. Always center the pan in the cooking zone.

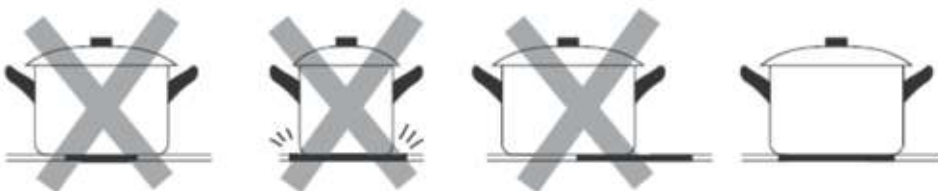



Always lift pan from hob - do not slide, or can scratch glass.



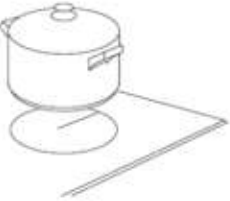

7. HOW TO USE

START COOKING

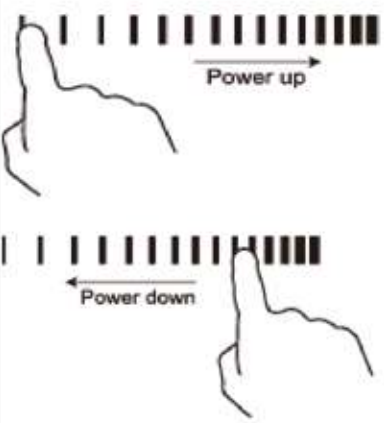
After power-up, the buzzer beeps once, all indicators light up for 1 second and then turn off, indicating that the glass-ceramic plate has entered the standby state.

<p>Touch the ON / OFF control. All indicators show "-"</p>	
<p>Place a suitable container in the cooking zone you wish to use.</p> <ul style="list-style-type: none">• Make sure that the bottom of the bowl and the surface of the cooking zone is clean and dry.	
<p>When you touch the cooking zone selection control, a Indicator next to the button will flash.</p>	
<p>Adjust the heat settings by touching the slider.</p> <ul style="list-style-type: none">• If you do not choose a heat setting within 1 minute, the Ceramic hob will turn off automatically. You will have to start over from the first step.• You can change the heat settings at any time during cooking.• You can change the power level from 0 to 9 of the slider.	

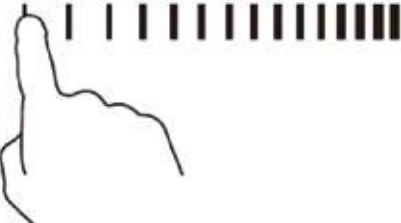
FINISH COOKING

Touch the selection control of the cooking zone you want to turn off.	
Turn off the cooking zone by pressing the slider a "L". Make sure the display shows "0"	
Turn off the entire stove by touching the ON / OFF key	



CARE FOR HOT SURFACES



"H" will show which cooking zone is warm to the touch. It will disappear when the surface has cooled to a safe temperature. It can also be used as a power saving function if you want to heat more saucepans, use the still hot cooking plate.

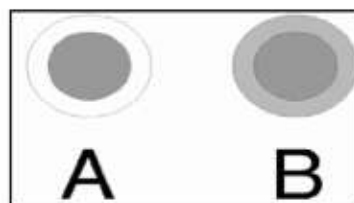
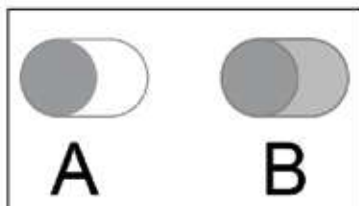

USING THE DUAL ZONE FUNCTION

- This function is only effective in cooking zones 1 and 2.
- The Dual Cooking Zone has two zones that can be used as the Central Section and the Exterior Section. You can use the center section (A) independently or both sections (B) at a time.

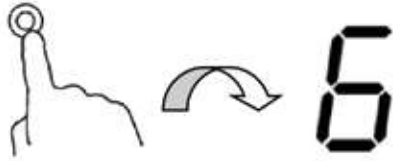

Activating the double circuit	
Press the cooking zone selection control in the cooking zone. double circuit (eg 6,)	
The power level indicator will flash, then press "⊙", after 5 seconds, the blink disappears, the Double double-circuit function is active and the power level shows "6" and "=" alternately.	
Deactivate double circuit	
Press the cooking zone selection control of the dual circuit zone, the power level indicator will flash.	
Press "⊙", the dual circuit function will be canceled, and the power level will return to "6".	

CONTROL LOCK

You can lock the controls to prevent unwanted use (for example, children Cooking zones enabled).

When the controls are locked, all controls except the ON / OFF control are disabled.

To lock the controls	
Touch the block control	The timer indicator will show "Lo"
To unlock the controls	
Make sure the hob is on	
Press and hold the lock control for a while.	

 When the hob is in lock mode, all controls are deactivated except the ON / OFF button, you can always turn the ceramic hob with the ON / OFF control in case of emergency, but you can unlock the hob for the first time in the next operation.





TIMER CONTROL

You can use the timer in two different ways:

- a) You can use it as a minute meter. In this case, the timer will not deactivate any cooking zone when the set time is higher.
- b) You can set it to switch off one or more cooking zones after the set time has elapsed. The maximum timer is 99 minutes.

USING THE TIMER AS MINUTE

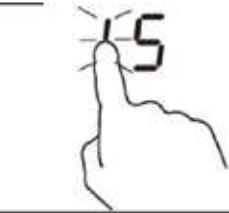





If you are not selecting any cooking zones

<p>Make sure that the stop is turned on.</p> <p>Note: You can use the minute hand, even if you have not selected any cooking zones.</p> <p>Touch the timer control, the "10" will be displayed on the timer screen. and the "0" blinks</p>	
<p>Set the timer by touching the slider. (e.g. 5)</p>	
<p>Touch the Timer control again, the "1" flashes.</p>	
<p>Adjust the time by touching the slider (EG9), now the timer is 95 minutes.</p> <p>When the time is set, the countdown will start immediately. The display will show the time.</p>	
<p>The buzzer will sound for 30 seconds and the timer indicator will show "- -" when the set time has expired.</p>	

Suggestion:

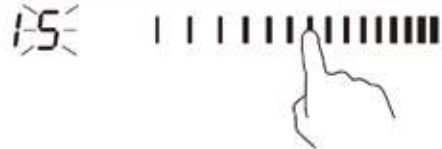
- Touch the "-" or "+" control of the timer once to decrease or increase by 1 minute.
- Touch and hold the "-" or "+" control of the timer to decrease or increase by 10 minutes.
- If the setting time exceeds 99 minutes, the timer will automatically return to 0 minutes.

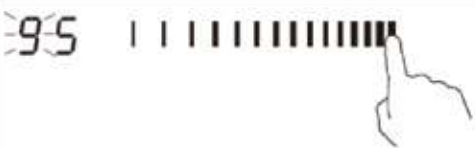
ADJUSTING THE TIMER TO ACTIVATE ONE OR MORE COOKING AREAS OFF

Set an area	
Touch the cooking zone selection control you want to set to the timer.	
Touch the timer control, the display shows the "10", the "0" flashes.	
When you touch "-" and "+" at the same time, the timer is canceled, and "-" is displayed in the minute display.	
Touch the timer control of New, the "1" flashes.	
Set the time by touching the slider (EG9), now the timer is in 95 minutes.	
When the time is set, the countdown will start immediately. The display will show the remaining time. When the cooking timer expires, the corresponding cooking zone will automatically turn off	



Note: The red light next to the power level indicator will illuminate indicating which zone has been selected...



If you want to change the time after the timer is set, you must start from step 1.

The method for establishing two zones is the same as the one mentioned above.

PROTECTION AGAINST TEMPERATURE

An equipped temperature sensor can control the temperature inside the glass ceramic plate. When an excessive temperature is monitored, the glass-ceramic will stop the operation automatically.

RESIDUAL HEAT WARNING

When the hob has been running for some time, there will be some residual heat. The letter "H" appears to warn you to stay away from her.

TIMES OF DEFAULT WORK

Another safety feature of the hob is the automatic switch-off. This happens when you forget to turn off a cooking zone. The defaults off times are shown in the following table:

Power level	1	2	3	4	5	6	7	8	9
Default working timer (time)	8	8	8	4	4	4	2	2	2

8. KITCHEN GUIDE



Be careful when frying as the oil and fat will heat up very quickly, especially if you are using Power Boost. At extremely high temperatures the oil and grease will ignite spontaneously and this presents a serious fire risk.

COOKING TIPS

WHEN THE FOOD LEADS TO THE BOILING, REDUCE TEMPERATURE ADJUSTMENT.

Using a lid will reduce cooking times and save energy by conserving heat.

Minimize the amount of liquid or fat to reduce cooking times.

Start cooking in a high setting and reduce the setting when the food has warmed up.

SLOW FIRE COOKING, RICE COOKING

- It occurs below the boiling point, at about 85 ° C, when the bubbles are only increasing once in a while for the surface of the cooking liquid. It is the key to delicious soups and tender stews because the tastes develop without overcooking the food. You should also cook egg-based flour and thickened sauces below the boiling point.
- Some tasks, including cooking rice by the absorption method, may require adjustment. The lowest setting to ensure that food is properly cooked at the recommended time.

BEEF STEAK

TO COOK TASTY FILLETS:

1. Let the meat rest at room temperature for about 20 minutes before cooking.
2. Heat a heavy skillet.
3. Brush both sides of the fillet with oil. Spray a small amount of oil in the hot pan and then lower the meat in the hot pan.
4. Rotate the meat only once during cooking. The exact cooking time will depend on the thickness of the meat and how cooked you want it. The times can vary between 2 and 8 minutes per side. Press the steak to measure how cooked it is - the firmer it feels the more "well done" it will be.
5. Let the steak rest on a warm plate for a few minutes to allow it to relax and become tender before serving.

FOR THE SARTEN

1. Choose a ceramic-compatible flat base wok or a large skillet.
2. Have all the ingredients and equipment ready. Stir-fry must be quick. If cooking large quantities, cook the food in several smaller batches.
3. Preheat the mold briefly and add two tablespoons of oil.
4. Cook meat first, set aside and keeps warm.
5. Stir the vegetables. When they are hot but still crisp, turn the cooking zone to a lower setting, return the meat to the pan and add your sauce.
6. Stir the ingredients gently to ensure they are heated through.
7. Serve immediately.

HEAT ADJUSTMENTS

The following settings are for guidance only. The exact setting will depend on several factors, including your cookware and the amount you are cooking. Experiment with the Ceramic Countertop to find the setting that best suits you.

Temperature control	Suitability
1 - 2	<ul style="list-style-type: none">• Delicate heating for small amounts of food• melt chocolate, butter and fast-burning foods• soft cooking• slow heating
3 - 4	<ul style="list-style-type: none">• Reheating• fast cooking Cooking rice
5 - 6	<ul style="list-style-type: none">• pancakes
7 - 8	<ul style="list-style-type: none">• Skipping• cook pasta
9	Sautéed <ul style="list-style-type: none">• Ember• bring the soup to a boil• boiling water

9. CUIDADO Y LIMPIEZA

What?	How?	Important!
Daily filthiness on the glass (fingerprints, marks, stains left by food or non-sugary spills in the glass)	<ol style="list-style-type: none"> 1. Turn off the stove. 2. Apply a stove cleaner while the glass is hot (but not hot). 3. Rinse and dry with a clean cloth or paper towel. 4. Turn the heater back on. 	<ul style="list-style-type: none"> • When the stove is switched off, there will be no indication of "hot surface", but the cooking zone may be hot. Be very careful. • Resistant sponges, some nylon scouring pads and abrasive cleaning agents can scratch the glass. Always read the label to check if you're cleaner or scourer is suitable. • Never leave cleaning residue on the cooking surface: the glass may stain.
Spilling hot sugar on the glass	<p>Remove them immediately with a blade or a razor blade scraper suitable for glass ceramic surfaces, but be careful with the surfaces of the hot cooking zone:</p> <ol style="list-style-type: none"> 1. Disconnect the power from the cooking grill on the wall. 2. Hold the blade or utensil at a 30 ° angle and scrape the dirt or spill into a cold area of the stove. 3. Clean dirt or spill with a kitchen towel or paper towel. 4. Follow steps 2 to 4 for "Daily dirt on glass" above. 	<ul style="list-style-type: none"> • Remove stains left by the Eat sugary or spilled food as soon as possible. If allowed to cool in glass, they can be difficult to remove or even permanently Damage the surface of the glass. • Cutting hazard: when the safety cover Retracts, the blade on a scraper It is sharp. Use with extreme Always keep and store safely and Out of reach of children.
Spill over's in the Touch controls	<ol style="list-style-type: none"> 1. Turn off the stove. 2. Absorb the spill 3. Clean the touch control area with a clean, damp sponge or cloth. 4. Clean the completely dry area With a paper towel. 5. Turn the heater back on. 	<ul style="list-style-type: none"> • The hob can rotate and rotate And the touch controls May not work while there is Liquid in them. Be sure to clean the touch control area before turning the stove on again.

SUGGESTIONS

Issue	Possible causes	What to do
The stove does not start.	No energy.	Make sure the hob is connected to the power source and is turned on. Check for a blackout in your home or area. If you have checked everything and the problem persists, call a technician.
The touch controls do not respond.	The touch controls do not respond.	Unlock the controls. See the section 'Using your hob' for instructions.
Touch controls are difficult to operate.	There may be a slight water film on the controls or you may be using your fingertip when touching the controls.	Make sure the touch control area is dry and use your finger ball when touching the controls.
The glass is being scratched.	Rough-edge kitchen utensils. Inadequate abrasive sponge or Cleaning products used.	Use kitchen utensils with flat and smooth bases. See "Choosing the right cookware". See "Care and Cleaning".
Some pans make clicking noises or noises.	This may be due to Construction of your kitchen utensils (Layers of different metals Different vibration).	This is normal for utensils do not indicate a fault.

10. INSTALLATION

INSTALLATION EQUIPMENT SELECTION

1. Cut the work surface according to the sizes shown in the drawing.

For the purpose of installation and use, a minimum space of 50mm should be kept around the hole.

Make sure the thickness of the work surface is at least 30 mm. Please select material from the heat-resistant and insulated work surface (do not use fibrous or hygroscopic material similar to the work surface unless impregnated) to avoid electrical shock and increased deformation caused by radiation of heat from the plate. As shown below:



Note: The safety distance between the sides of the hob and the interior surfaces of the hob s must be at least 3 mm.

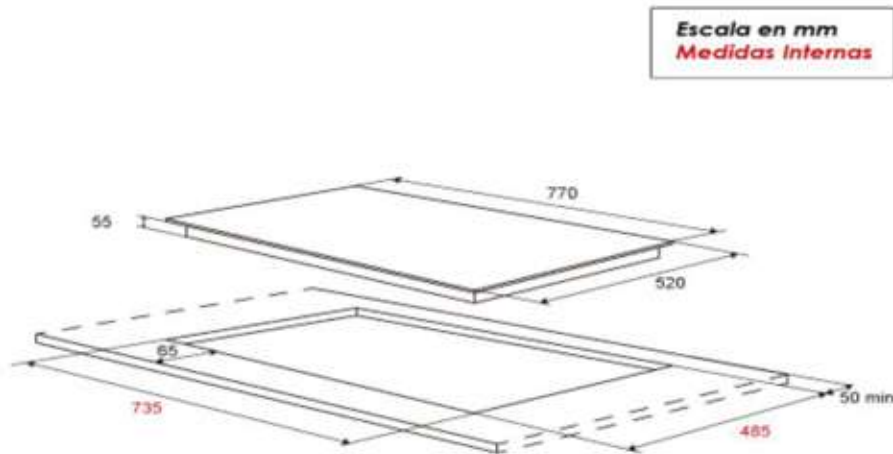

A	B	C	D	E	F	G
770	520	55	46	750 + 41	495 + 41	50 mini-

2. The glass ceramic hob can be used on the top of the cabinet table. The glass ceramic plate should be placed horizontally. As shown below:

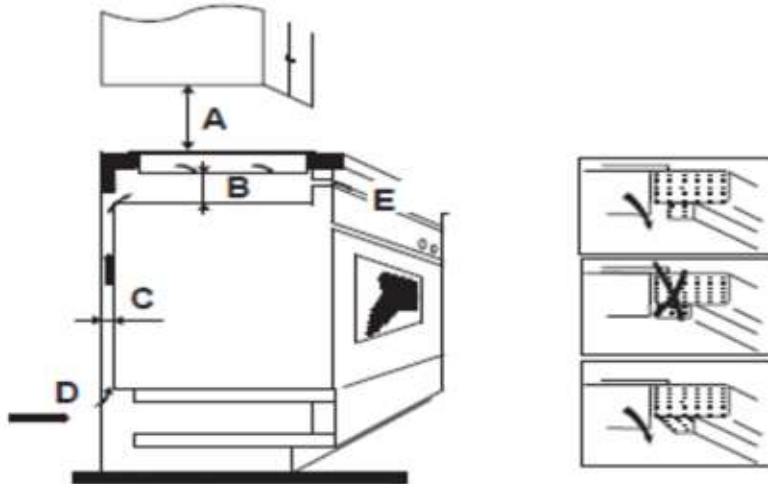

A(mm)	B(mm)	C(mm)	D	E
760	50 mini	20 mini	Air road	Air vent 5mm

In any case, make sure the hob is well ventilated and that the air inlet and outlet are not blocked. Make sure that the ceramic hob is in good working order. As shown below



Note: The safety distance between the hob and the cabinet above the hob must be at least 760 mm.

WARNING: Ensure adequate ventilation

Make sure that the glass ceramic is well ventilated and that the air inlet and outlet are not obstructed. To prevent accidental contact with the worktop's overheating bottom or an unexpected electric shock during work, it is necessary to place a screw-in wooden insert at least 50 mm from the bottom of the worktop. Follow the following requirements.



There are ventilation holes around the worktop. You **MUST** ensure that these holes are not blocked by the hob when you set the hob in position.

- • Keep in mind that the glue that attaches the plastic material or wood to the furniture, must withstand the temperature of not less than 150 °C, to avoid the detachment of the panels.
- • The back wall, adjacent and surrounding surfaces must be capable of withstanding a temperature of 90 ° C.
-

BEFORE PLACING THE FASTENING BRACKETS

The unit should be placed on a stable and smooth surface (use the packaging). Do not apply force to the controls protruding from the hob.

Fasten the hob to the work surface by means of the four bracket screw on the bottom of the hob (see picture) after installation. Adjust the position of the stand to fit the thickness of the work surface.

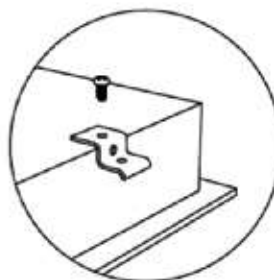
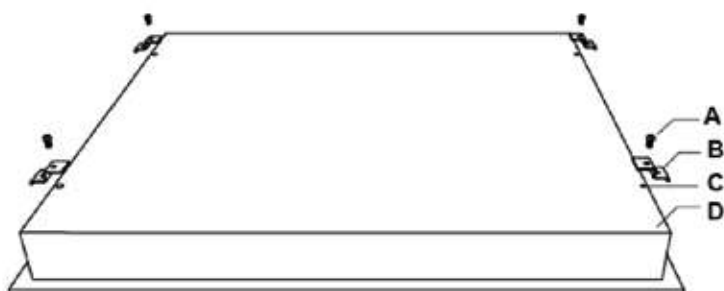

Under any circumstances, the brackets can not the inner surfaces of the work place after installation (see photo).

PRECAUTIONS

1. The glass ceramic hob must be installed by qualified personnel or technicians. We have professionals at your service. Please never do the operation yourself.
2. The glass ceramic hob should not be mounted on refrigeration equipment, dishwashers and rotary dryers.
3. The glass ceramic plate shall be installed in such a way as to ensure a better heat radiation to increase its reliability.
4. The wall and the zone of induced heating above the work surface must resist the heat.
5. To prevent damage, the sandwich layer and adhesive must be heat resistant.
6. Do not use a steam cleaner.
7. This ceramic can only be connected to a source with system impedance of no more than 0.427 ohms. If necessary, consult your marketing authority.
8. System Impedance Information.

CONNECTING THE PLATE TO THE ELECTRICAL NETWORK

The electrical power system of an electric or induction cooktop, must include:

- A double breaker of 20A on each side minimum.
- A number 10-gauge cabling.

It must be installed to a ground source not a neutral!

The ground source will protect the equipment of any sudden change in voltage and will prevent electrical damage overtime. The power supply must be connected in accordance with the corresponding standard, or a unipolar switch. The connection method is shown below.

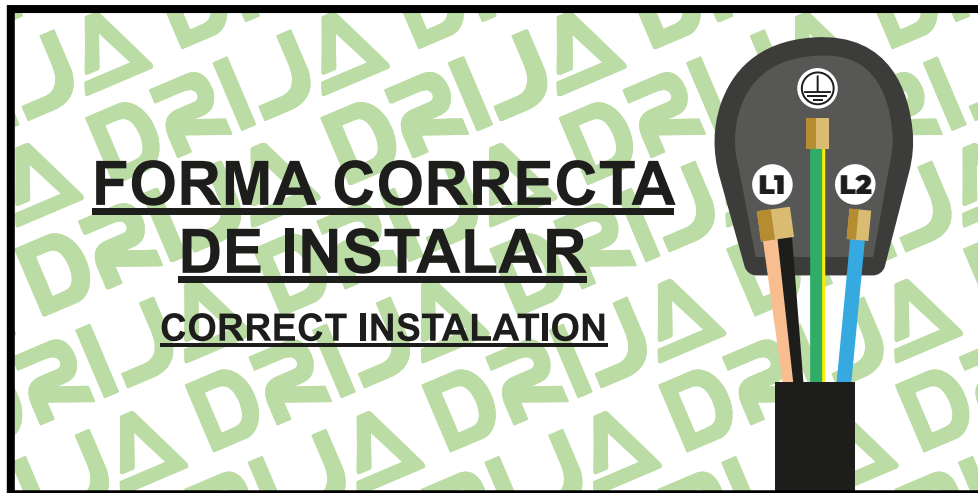

1. If the cable is damaged or needs to be replaced, it should be done by an aftermarket technician using the proper tools to avoid accidents.
2. If the heater is connected directly to the mains, a single pole switch with a minimum space of 3 mm must be installed between the contacts.
3. The installer must ensure that the correct electrical connection has been made and that it complies with safety regulations.
4. The cable should not be bent or compressed.
5. The cable should be regularly checked and only replaced by a properly qualified person.



The bottom surface and the power cable of the hob are not accessible after installation.



**ELIMINATION: No
Remove This Product
As municipality
Waste.**

**Collection of
Separate waste
For special treatment is
necessary.**

This stove is labeled in accordance with the European Directive 2012/19 / EU for Waste Electrical and Electronic Equipment (WEEE). Ensuring that this stove is properly disposed of will help prevent any possible harm to the environment and human health, which could otherwise be caused if it were disposed of in the

Wrong Way.

The symbol on the product indicates that it cannot be treated as a normal residue. It should be taken to a collection point for the recycling of electrical and electronic products.

This stove requires the special disposal of waste. For more information about treatment, recovery and recycling of this product, contact your local council, your household waste disposal service or the store where you purchased it.

For more detailed information on the treatment, recovery and recycling of this product, please contact your local city office, the household waste disposal service or the shop where you purchased the product.

PROTEGE
TU GARANTIA

La garantía **NO** cubre daños
causados por su mala instalación

WARRANTY DISCLAIMER

Warranty doesn't cover any product damage
due to wrong installation